

**OLYMPUS**

**OLYMPUS  
OM-2**

**INSTRUCTIONS**

---

### To an OM-2 Owner

The OM-2 is a unique 35mm single lens reflex, utilizing the Olympus TTL Direct (Off-the-Film) Light Measuring System for unprecedented accuracy of automatic exposure.

In addition, it offers full manual exposure control at the flip of a lever switch. OM-2 has set a new standard for reliability and versatility in a compact SLR, to meet the demands of the professional and amateur alike, for standard as well as scientific and technical photography pursuits.

OM-2 is part of the total Olympus OM System, enabling you to capture life as it happens, from photomicrography to astrophotography, from photojournalism to portraiture. With its many system components, the OM-2 permits an infinite range of photographic capabilities ... a camera that grows as your needs expand. To get the optimum results from your OM-2, carefully study this Owner's Manual. It is well worth your time, and will provide a sound basis for years of fine OM-2 photographs.

## DESCRIPTION OF CONTROLS

Refer to pages in parentheses for detailed explanations of each part.

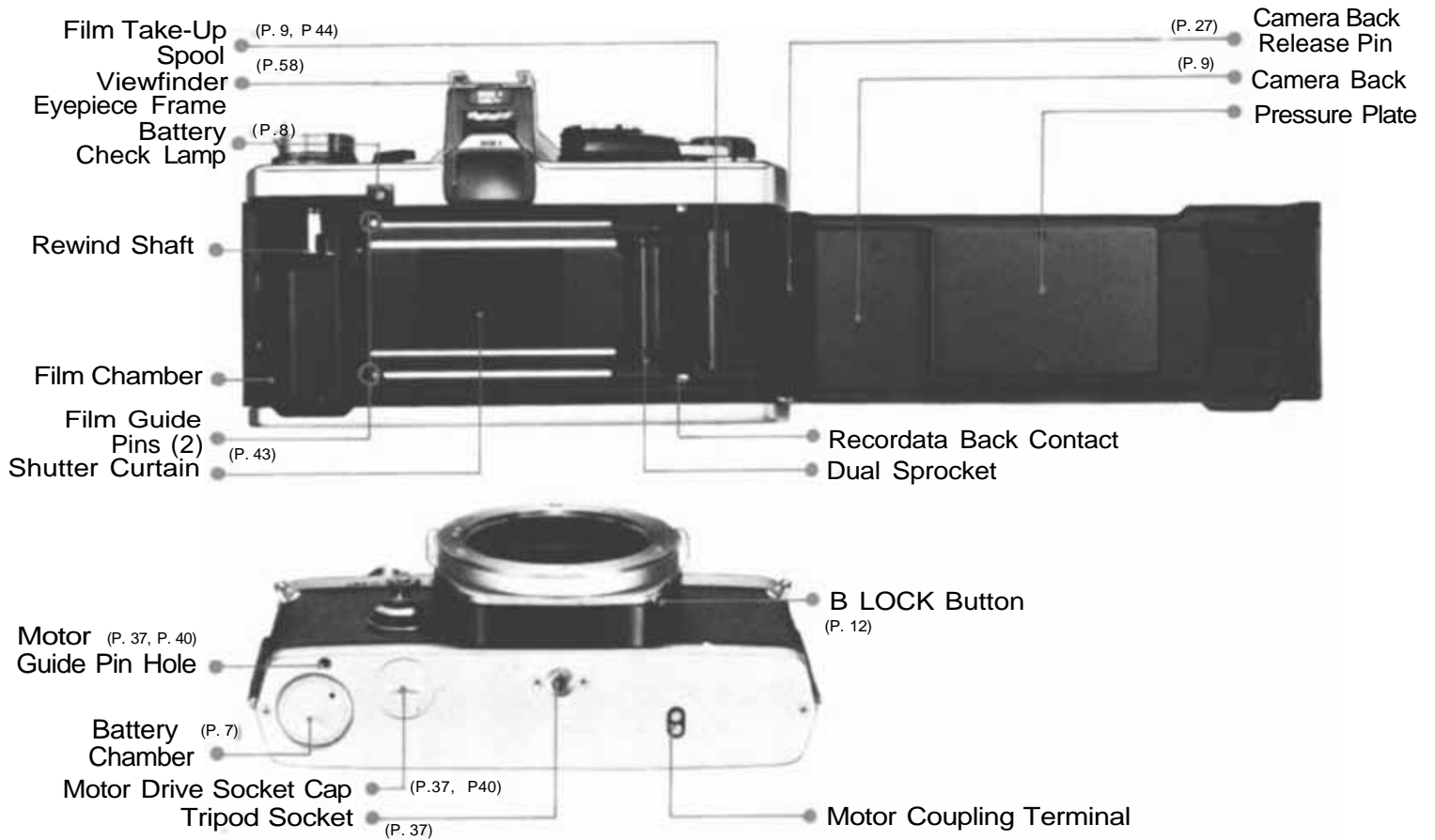

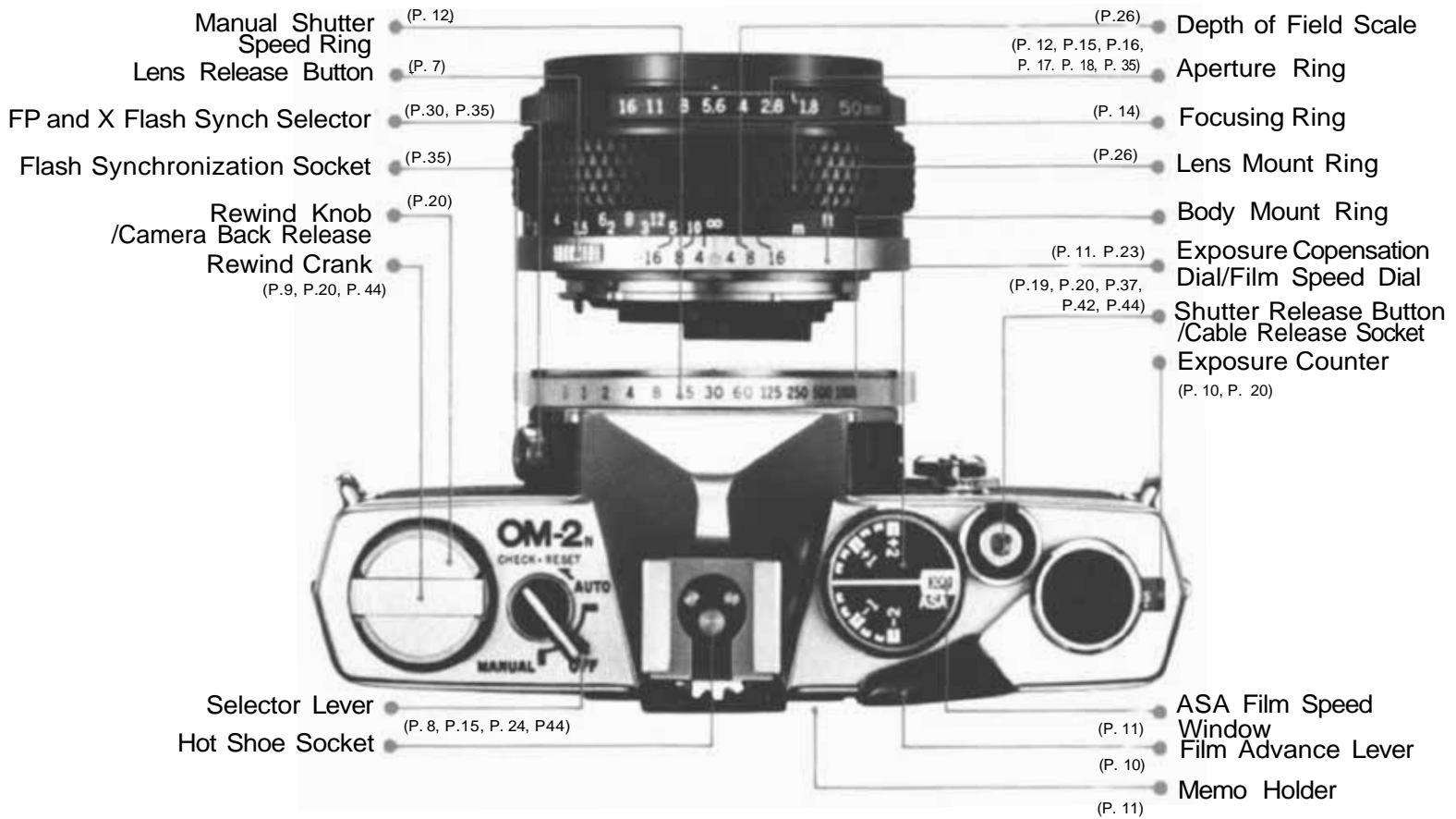

Rewind Release Lever (P.20, P.44)

Accessory Shoe 4  
Shoulder Strap Eyelet

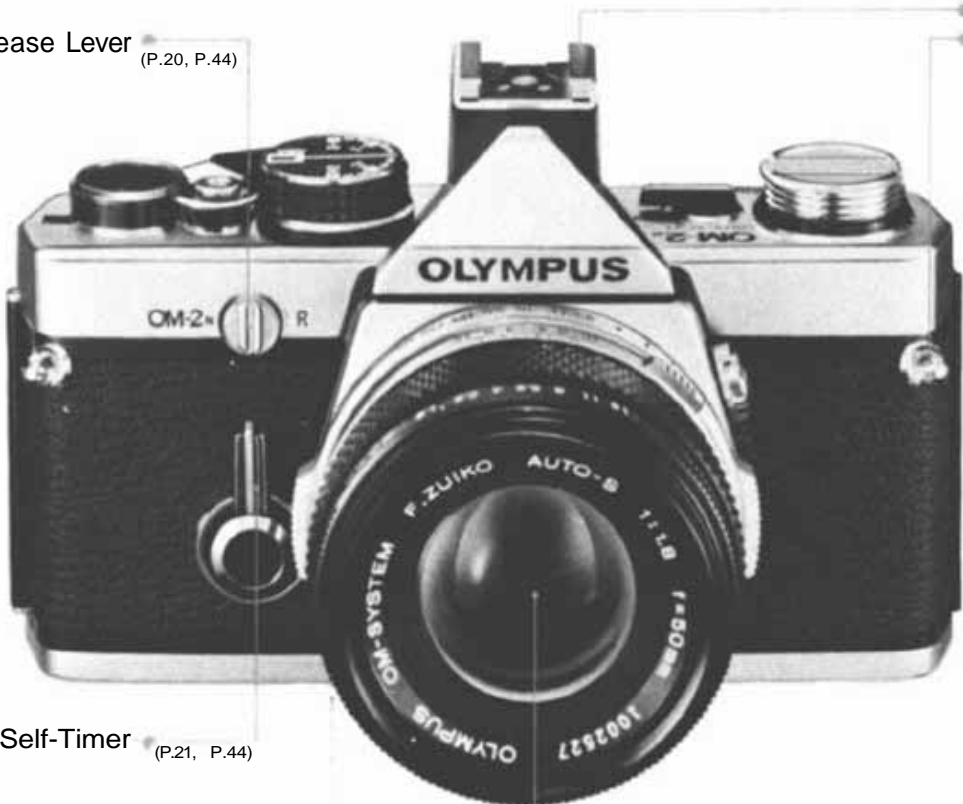

Self-Timer (P.21, P.44)

Depth-of-Field Preview Button (P. 25, P. 26.)

Lens

## TABLE OF CONTENTS

---

### On OM-2

● To an OM-2 Owner . . . . .	1	● Holding the Camera . . . . .	19
● Description of Controls . . . . .	2	● Unloading the Camera/Making Multiple Exposures . . . . .	20
● Mounting the Lens/Inserting the Batteries . . . . .	7	● Setting the Self-Timer . . . . .	21
● Battery Check and Mirror Lock-Up . . . . .	8	● Exposure Compensation . . . . .	22
● Loading the Film . . . . .	9	● Exposure Compensation for Automatic Measurement . . . . .	23
● Operating the Film Advance Lever/ Exposure Counter . . . . .	10	● Exposure Compensation for Manual Measurement . . . . .	24
● Setting the ASA Film Speed Dial . . . . .	11	● Depth of Field . . . . .	25
● Aperture Ring and Manual Shutter Speed Ring . . . . .	12	● Depth of Field Scale/Preview Button . . . . .	26
● Setting the Selector Lever/Viewfinder . . . . .	13	● Infrared Photography/Camera Back Replacement . . . . .	27
● Focusing . . . . .	14	● Interchangeable Focusing Screens . . . . .	28
● Automatic Exposure Control . . . . .	15	● Flash Photography with the T32 (T20) Electronic Flash . . . . .	29
● Manual Exposure Control . . . . .	17		

### On OM System

- The T32, (T20)/OM-2 Way — Flash  
Photography Couldn't Be Simpler and  
More Accurate . . . . . 32
- Bounce Flash . . . . . 33
- Close-up Flash . . . . . 34
- Flash Photography with an Electronic  
Flash Unit . . . . . 35
- Flash Bulb Photography . . . . . 36
- Motor Drive Photography . . . . . 37
- Winder 2 Operation . . . . . 40
- Care and Storage . . . . . 42
- Questions and Answers . . . . . 44
- The Most Important Feature of the  
OM-2 — TTL Direct (off-the-film) Light  
Measuring . . . . . 47

- Zuiko Interchangeable Lens Group . . . . . 51
- Table of Interchangeable Lenses . . . . . 53
- Interchangeable Lens Group Units . . . . . 55
- Finder Group . . . . . 57
- Finder Group Units . . . . . 58
- Flashphoto Group . . . . . 61
- Flashphoto Group Units . . . . . 64
- Motor Drive Group . . . . . 71
- Motor Drive Group Units . . . . . 74
- Macrophotography Group . . . . . 76
- Macrophotography Group Units . . . . . 78
- Phototechnical Group . . . . . 84
- Phototechnical Group Units . . . . . 88
- Photomicrography Group . . . . . 89
- Photomicrography Group Units . . . . . 92
- Chart of Photographic Ranges . . . . . 94
- Case Group and Units . . . . . 95

## MOUNTING THE LENS



### Mount the Lens.

Align the red dots on the lens flange and the body mount ring. Turn the lens clockwise until the lens release button springs up and you will hear positive "click".

### Lens Removal

To detach the lens, press down on the lens release button and turn the lens counter-clockwise. Always attach the front and rear lens caps when the lens is removed from the body to prevent any possibility of damage.



## INSERTING THE BATTERIES

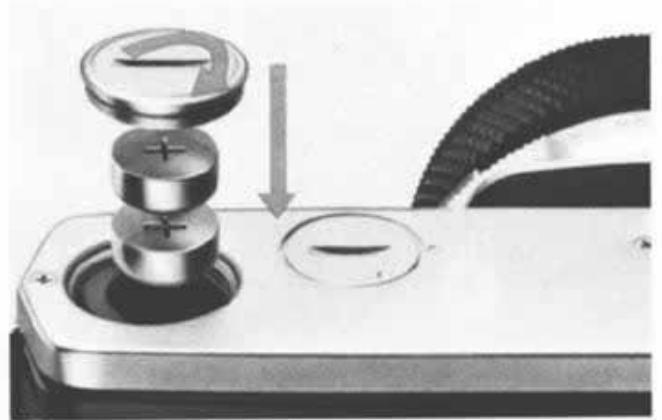

Insert two 1.5V silver oxide batteries SR44 (Eveready EPX-76 or equivalents) into the battery chamber.

**CAUTION:** Batteries should be always replaced as a pair. If battery polarity is incorrect, the camera does not function.

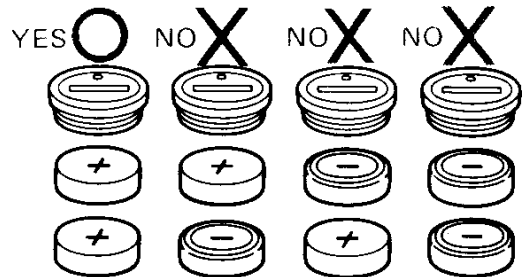



## BATTERY CHECK AND MIRROR LOCK-UP

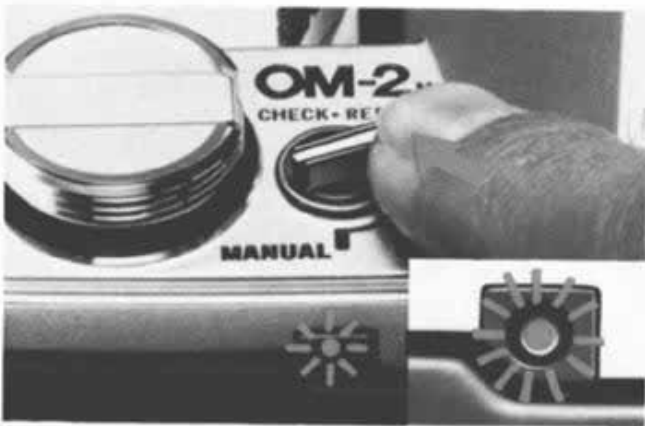

By pressing the selector lever to the "CHECK•RESET" position, you can check the batteries and/or unlock the mirror.

### Check the Batteries.

Move the selector lever to the "CHECK•RESET" position. The battery check lamp indicates battery condition as follows:

- ① The red lamp lights brightly — Battery voltage is sufficient.
- ② The red lamp flashes on and off — Batteries are very weak. Fresh batteries are recommended.
- ③ The lamp does not light — Batteries are drained. Replace them.

**NOTE:** Silver oxide batteries will last approximately one year. To avoid battery drain, make it

a point to switch off the selector lever when the camera is not used.

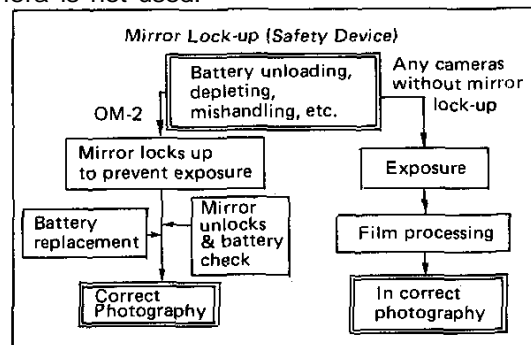

### Mirror Lock-Up

If the mirror is up, the field of view turns dark through the viewfinder, and the film cannot be advanced. This lock-up of the mirror occurs when ① no batteries are loaded or batteries are depleted, or ② the film is advanced during exposure. The mirror lock-up does not indicate any breakdown of the camera, but a built-in safety device to prevent any trouble. Press the selector lever to the "CHECK•RESET" position, and unlock the mirror. In case ②, shooting can be resumed immediately. In case ①, replace batteries.

**CAUTION:** You cannot unlock the mirror after battery replacement, if you omit pressing the selector lever to the "CHECK•RESET" position.

**NOTE:** When the mirror locks up, a battery drain prevention device is activated to conserve power.

## LOADING THE FILM

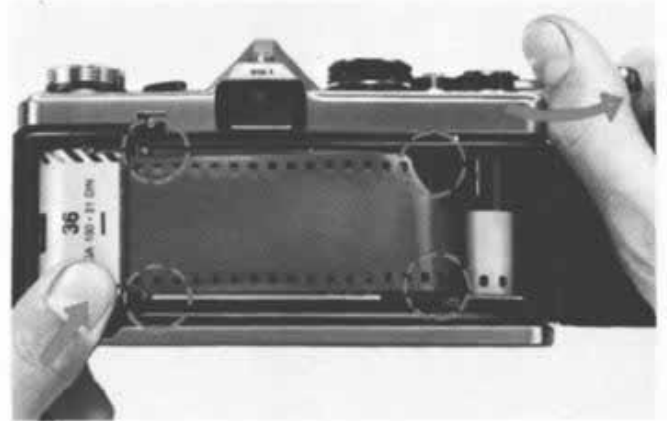
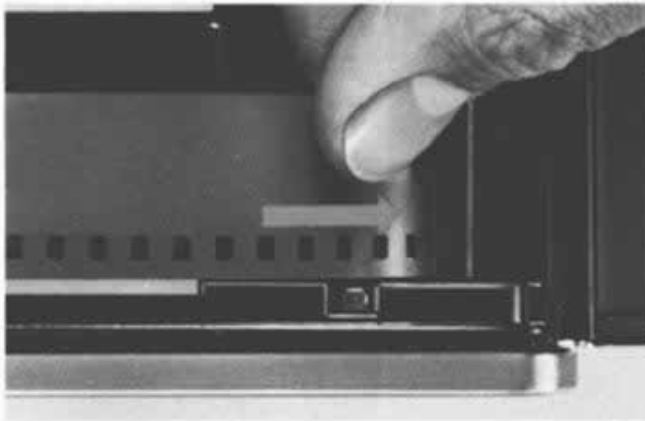

- ① Pull the rewind knob up and open the camera back.
- ② Insert a film cartridge into the film chamber and push the rewind knob back.
- ③ Insert the film leader into one of the slots in the film take-up spool.

YES

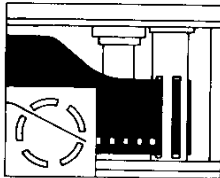

X  
NO

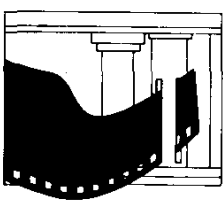

X  
NO

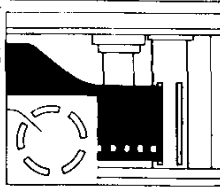

- ④ Turn the advance lever so that the film perforations engage the sprocket teeth.
- ⑤ Close the camera back until it clicks.
- ⑥ Make sure the selector lever is in the OFF position.

**NOTE:** Fold out the rewind crank and rotate it clockwise slightly to remove any slack in the film. Then if the rewind crank rotates as you turn the advance lever, the film is properly advancing.

## OPERATING THE FILM ADVANCE LEVER

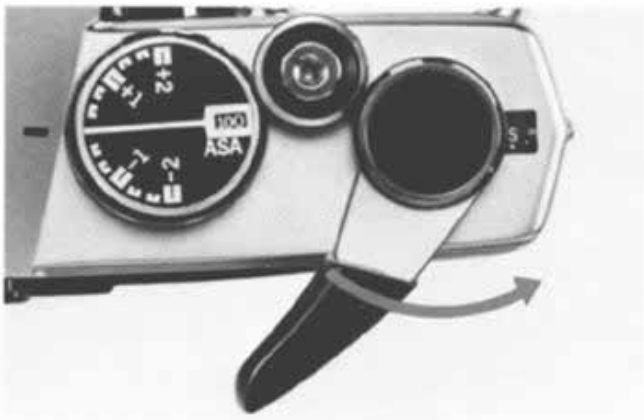

Turn the advance lever to the right as far as it will go. The film can be advanced by one frame, in a single stroke or in multiple short strokes.

**NOTE:** If the advance lever stops moving because you've shot the last remaining film frame while you are advancing the film, discontinue the film advance and rewind the film. (Read pages 37~41 for motor drive shooting.)

## EXPOSURE COUNTER

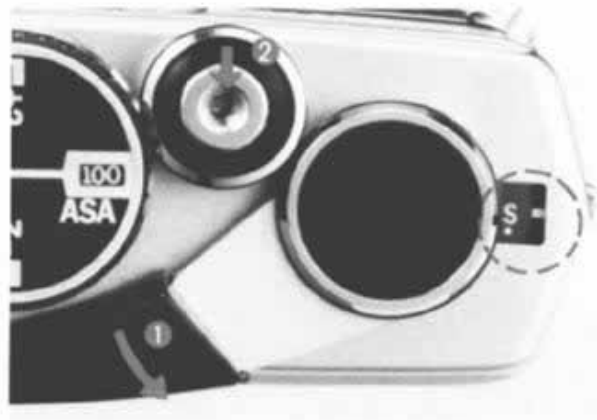

### Exposure Counter

The exposure counter is indexed from "S" (Start) to 1, 2 ... up to 36 in even numbers and "E" (End). Whenever the camera back is opened, the exposure counter automatically returns to "S".

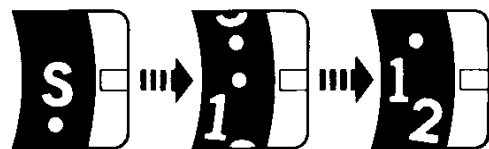

## SETTING THE ASA FILM SPEED DIAL



- ① Lift up the outer collar of the exposure compensation dial and rotate until the ASA speed for the film appears in the window.
- ② The ASA film speed scale on the dial is marked from 12 to 1600. If you are not able to rotate the outer collar to the desired ASA in one turn of the dial (only 3 stops can be rotated in one turn of the dial), release the collar and turn the exposure compensation dial several click stops in the opposite direction from the ASA you are trying to set. Then, lift the outer collar again and continue turning to the desired ASA setting. NEVER FORCE THE DIAL WHEN SETTING ASA.

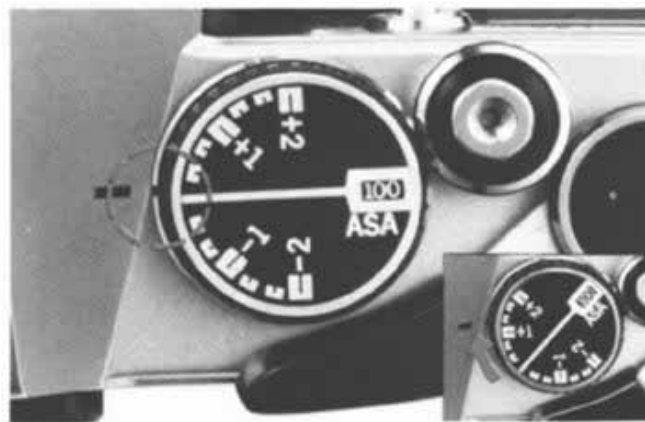

- ③ Once the setting has been made, turn the dial until the white line is aligned with the black index line on the pentaprism housing.

**CAUTION:** Make sure you align the white line with the black index line on the pentaprism after setting ASA.

### ■ THE MEMO HOLDER

A memo holder provided on the camera back accepts a memo slip or the end flap from most 35mm film packages as a reminder of ASA, exposure number, etc.

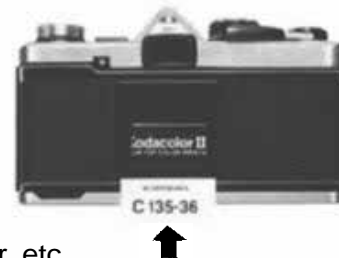

## APERTURE RING AND MANUAL SHUTTER SPEED RING



### Aperture Ring

The opening (aperture) in the lens diaphragm is marked in F stops on the aperture ring. The higher the F number, the smaller the lens opening (less light) and provides greater depth of field than lower F numbers (see page 25).

When setting the aperture ring, you may use either the click-stop positions or any in-between settings to obtain precise exposure control.

**NOTE:** All lenses in the OM System (except certain specialized lenses) provide fully automatic diaphragm control allowing you to focus and compose your picture with the lens fully open. The diaphragm will automatically close to the pre-selected F stop at the moment of exposure. And immediately re-open after exposure.

### Manual Shutter Speed Ring

Shutter speeds engraved on the manual shutter speed ring are used only for non-automatic camera operation. B indicates "bulb" at which setting the shutter will remain open as long as the shutter release button is held down. The other engravings indicate fractions of a second; for example "T" for 1 second, "2" for 1/2 second ..... up to "1000" for 1/1000 second. To set at "B", rotate the ring while pressing the B LOCK button at the lower left of the body mount.

Be careful that shutter speeds are set only at click stop positions. Make sure that the selector lever is set at a click stop position.

## SETTING THE SELECTOR LEVER



The selector lever on top of your camera has four positions as follows (with click stops at AUTO-OFF-MANUAL):

- 1) **AUTO** — Automatic exposure control; you preset the F stop and the camera automatically sets shutter speed for proper exposure.
- 2) **OFF** — Camera turned completely off to avoid battery drain. Always store your camera with the selector lever in this position.
- 3) **MANUAL** — Zero-method exposure operation; set shutter speed and F stop for proper exposure (see page 17).
- 4) **CHECK•RESET** — Battery test position simultaneously with release of mirror lock-up.

## VIEWFINDER

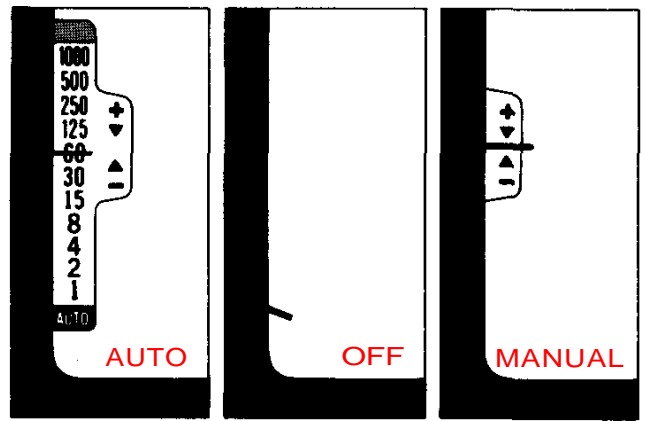

The three-position viewfinder control center allows you to see the operating mode of your camera without checking the position of the selector lever.

**NOTE:** If you release the shutter with the selector lever at OFF in normal lighting condition, the built-in automatic exposure control is activated to take a properly-exposed picture, so as not to miss optimum exposure opportunity, at any moment. The difference between the automatic exposures in the OFF position and the AUTO position, however, is that the OFF mode exposure stops in 1/30 sec. maximum to save battery exhaustion, and the AUTO viewfinder scale does not appear.

## FOCUSING

OLYMPUS  
OM-2



▲ In focus.

Look through the viewfinder and turn the focusing ring in either direction until your subject appears sharpest. The split image will be vertically aligned in the central spot of the Focusing Screen or a shimmering effect of the microprism ring around the central spot will disappear when critical focusing has been achieved.

**NOTE:** You can determine the distance between the subject and the film plane by reading the distance scale on the focusing ring after setting critical focusing. The actual distance is indicated opposite the red central index mark on the lens mount ring; the white scale indicates this distance in meters and the orange scale in feet.

(For Focusing Screen replacement read pages 28, 59 and 60).



▲ Out of focus.

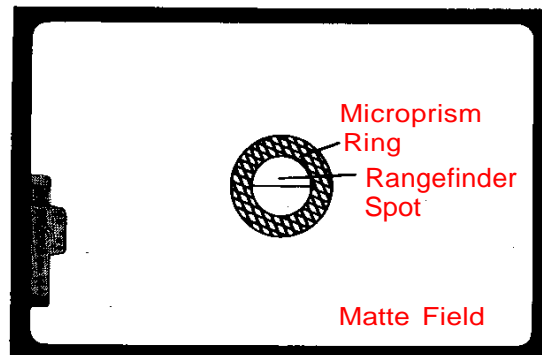

## AUTOMATIC EXPOSURE CONTROL



### The Aperture-Preferred System

The aperture-preferred system is the most convenient and easy-to-use method of automatic operation, particularly outdoors when using 50mm or wide-angle lenses. To use this system:

- ① Set the selector lever to the "AUTO" position making sure that the lever "clicks" into place.
- ② Set the F stop you wish to use on the lens aperture ring.
- ③ The camera will automatically determine the shutter speed required for proper exposure and indicate that speed in the viewfinder. Then RE-

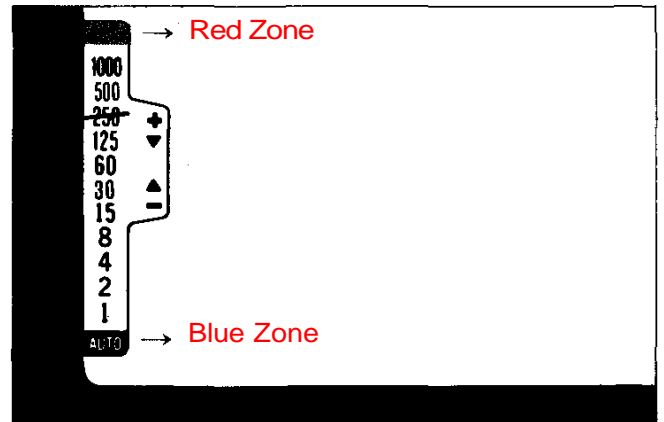

LEASE THE SHUTTER.

**NOTE:** At shutter speeds slower than 1/60 second, the possibility of camera movement during exposure is increased. If the needle in the viewfinder indicates a shutter speed in this area, turn the aperture ring to the left (so as to open the aperture).

For use of interchangeable lenses of various angles of view, refer to the data below to determine the hand-held shutter speed and avoid blurry pictures:

- ① Wide-angle and super wide-angle lenses — 1/30 second or faster.
- ② 50mm lenses — 1/60 second or faster.
- ③ Telephoto and Zoom lenses to 100mm — 1/125 second or faster.
- ④ Telephoto and Zoom lenses to 200mm — 1/250 second or



faster. ⑤ Super telephoto lenses of 300mm and up — 1/500 second or faster.

④ If the viewfinder needle enters the red zone → **Warning against over-exposure.** A shutter speed faster than 1 /1000 second is required for proper exposure, but the shutter will be released at 1/1000 second. Since this is beyond the range of your OM-2 and an overexposed photograph would result, turn the lens aperture ring to a higher F stop until the meter needle moves out of the red zone.

⑤ If the viewfinder needle enters the blue "AUTO" zone → **Indication for long time exposure.** A shutter speed longer than 1 second is required for proper exposure.

Your OM-2 provides for automatic exposures from 1 second to 120 seconds (with ASA 100 at normal temperature and humidity). If you wish to close the shutter during a long time exposure under AUTO operation, turn the selector lever to the OFF position, and the shutter closes.

**CAUTION:** Do not advance the film while the mirror is up during an automatic exposure, or the mirror will lock up.

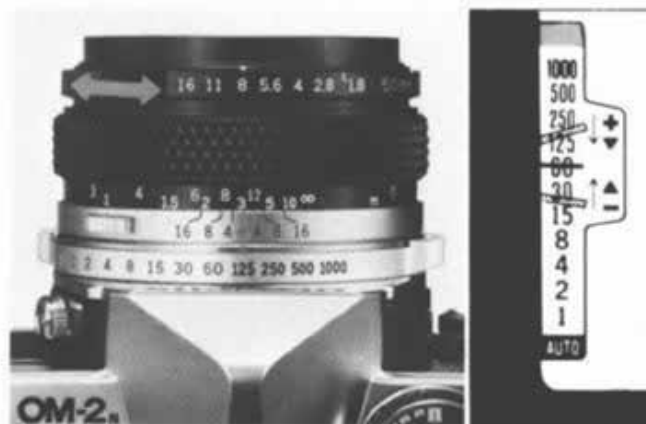

#### The Shutter Speed-Preferred System

Should you wish to select a shutter speed to meet a specific photographic situation (e.g., stopping fast action, eliminating camera movement or controlling depth-of-field), you may use a shutter speed-preferred method of automatic exposure control. To use this system:

- ① Set the selector lever to the "AUTO" position.
- ② Look through the viewfinder and turn the aperture ring until the viewfinder needle points at the desired shutter speed.

## MANUAL EXPOSURE CONTROL



Set the selector lever to "MANUAL", and the exposure index marks and the meter needle are visible in the viewfinder.

### Shutter Speed-Preferred Manual Exposure Control

- ① Should you wish to preselect a shutter speed turn the shutter speed ring until the desired speed is opposite the red reference dot on the lens barrel (see page 12).
- ② Look through the viewfinder and turn the aperture ring until the needle lines up in the center of the index. For fine exposure adjustment you can use any click-stop or intermediate F stop position.



### Aperture-Preferred Manual Exposure Control

- ① Turn the aperture ring until the desired F stop is opposite the white index mark.
- ② Look through the viewfinder and rotate the shutter speed ring until the needle lines up as close as possible to the center of the index. Make sure that the shutter speed ring is clicked into position and not between two settings.
- ③ Make the final exposure adjustment by turning the aperture ring until the needle aligns exactly in the center of the index.

**CAUTION:** The shutter speed thus obtained should meet the other photographic conditions properly, especially at "B" where the shutter speed ring is not coupled with the exposure meter.

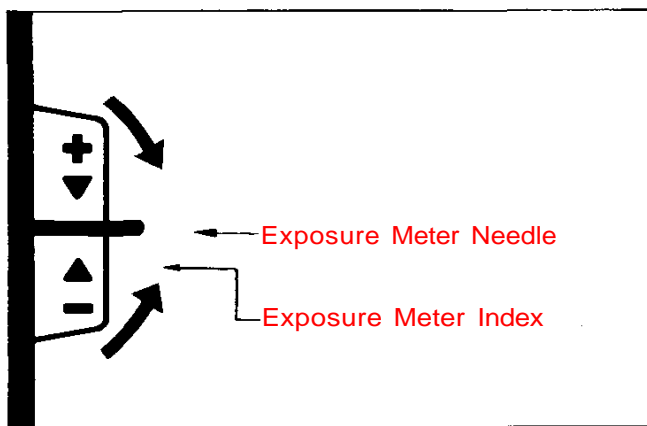

### If the Exposure Needle Does Not Center on the Index

If an exposure or a shutter speed is improperly selected, the exposure needle will not center on the index. Reset the shutter speed or F stop until the needle is centered.

You may use an ND (neutral density) filter if the subject is too bright, or an electronic flash or flash bulb if the subject is too dark.

ASA 100	50mm F1.8 lens, fully opened	1/2 sec.
ASA 100	50mm F1.4 lens, fully opened	1/2 sec.
ASA 100	55mm F1.2 lens, fully opened	1/2 sec.

### Light Measuring Range of the Exposure Meter

The measuring range is EV 1.5-EV17 (ASA 100, with F1.2 55mm lens). The list above summarizes the lowest measurable limits in dealing with extreme low light conditions.

**CAUTION:** If the aperture ring or shutter speed ring is turned below the limits in the list, with extremely low lighting or the selector lever OFF, the needle sometimes moves, but the meter is not functioning.

## HOLDING THE CAMERA

---



Proper camera handling is important in assuring the sharpest possible pictures.

### **Holding the Camera Horizontally**

Keep both elbows close to the body, to steady the camera.

### **Putting the Camera into Operation**

The aperture ring, focusing ring and shutter speed ring are so arranged as to enable one hand operation right up to the moment the shutter is released. Hold your breath at the moment of shutter release. Transport the film advance lever with your right thumb and squeeze the release button smoothly using the cushion, not the tip, of your index finger.



### **Holding the Camera Vertically**

For vertical shooting, keep one elbow close to your body and press the camera tightly against your forehead.

**NOTE:** Steady yourself against any nearby support (such as a tree, fence, or wall) whenever possible.

**NOTE:** For telephotography, or slow shutter speed photography, it is recommended that you use a tripod and hold the camera steady with your hands.

## UNLOADING THE CAMERA

## MAKING MULTIPLE EXPOSURES



When the entire roll of film has been exposed rewind the film.

- ① Turn the rewind release lever counter-clockwise by about 90°.
- ② Fold out the rewind crank and wind it in the direction of the arrow. While rewinding, you will feel tension on the crank. When the tension stops and the crank turns freely, the film has been completely rewound back into the cartridge.
- ③ Open the camera back by pulling up on the rewind knob and remove the film cartridge. Keep camera and film out of direct sunlight while unloading.

Should you wish to make more than one exposure on the same frame:

- ① Take up any slack in the film by slowly turning the rewind crank in a clockwise direction until it stops, then take the first exposure.
- ② Turn the rewind release lever counter-clockwise by about 90°.
- ③ Hold both the rewind knob and rewind release lever to prevent them from turning and advance the film advance lever. The shutter will then be cocked for the next exposure without advancing the film.
- ④ Press the shutter release button with a slow, steady squeeze.
- ⑤ The exposure counter will advance with each exposure.
- ⑥ After completing the multiple exposures, put the lens cap on the lens, advance the film, and shoot a blank frame to avoid overlapping.

**NOTE:** You can make as many multiple exposure as you like by repeating the above procedure. With each exposure on the same frame, the possibility of slippage is increased.

## SETTING THE SELF-TIMER

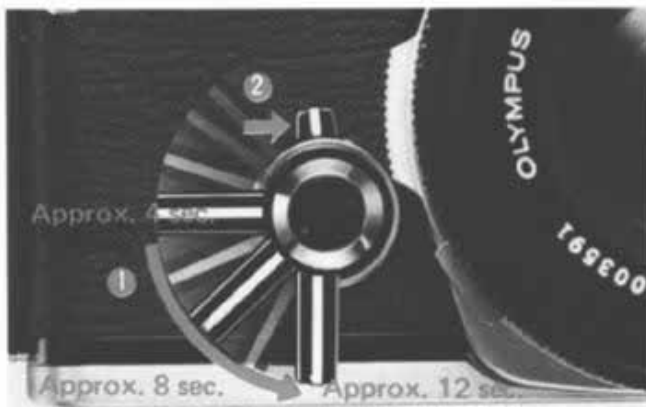

- ① Rotate the self-timer lever counter-clockwise so that the shutter can be released after an elapse of delay time between 4 sec. to 12 sec. according to the lever setting as shown above. You may set the self-timer lever either before or after advancing the film.
- ② Turn the start lever clockwise to the vertical position to activate the self-timer lever. The shutter will then be released after the preset time.

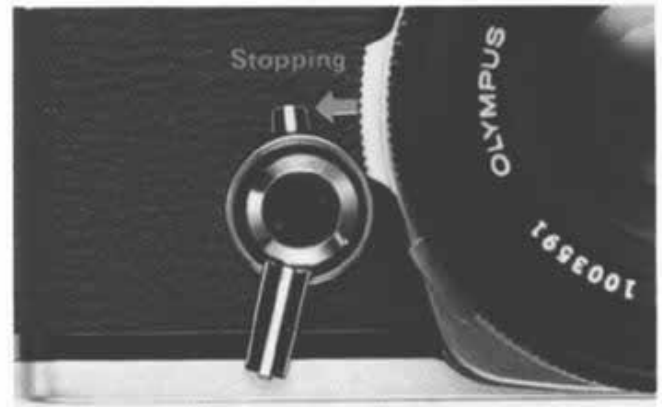

### Stopping the Self-timer

To stop the self-timer during its operation, turn the start lever counter-clockwise. If you turn the start lever clockwise again, the self-timer can resume its action.

**NOTE:** After setting the lever, you can release the shutter by pressing the shutter release button.

**NOTE:** If you do not reset the self-timer, the timer lever will begin moving immediately after advancing the film and the shutter will be released earlier than expected. If the film has not been advanced fully, the timer lever will stop half-way. To re-activate the timer, move the start lever counter-clockwise to stop the timer lever, return the timer lever to the starting position, and advance the film. Then, turn the start lever again.

## EXPOSURE COMPENSATION



▲ After compensation



Before compensation ►

When the most important area of the picture is much darker than the general picture area (blue sky, snowfield, etc.), the meter will have a tendency to read the brightest part of the picture leaving the main subject under-exposed. Alternatively, when taking a picture of a bright subject against a dark background the meter tends to read the darkest part



▲ After compensation



Before compensation ►

leaving the main subject over-exposed. In these situations, proper exposure compensation helps you take fine pictures.

**NOTE:** With backlighting or sidelighting it's always a good idea to use a lens hood to eliminate unwanted glare.

## EXPOSURE COMPENSATION FOR AUTOMATIC MEASUREMENT

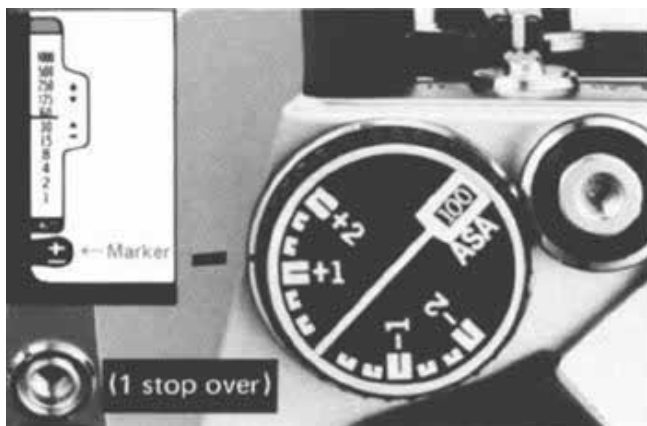

If you wish to change the exposure setting automatically selected by the camera, use the exposure compensation dial and a compensation marker appears in the viewfinder.

**When the main subject is much darker** than the general background or when strong light strikes the subject from behind or from the side, turn the dial **to the (+) side**.

Turn the camera to the subject so that the subject fills most of the viewfinder, or move the camera toward the subject. After reading the shutter speed, return to the original position and rotate the compensation dial until the meter needle points at the read-out speed in the finder.

**NOTE:** In such a case it is recommended to turn the compensation dial to the + 1 side.

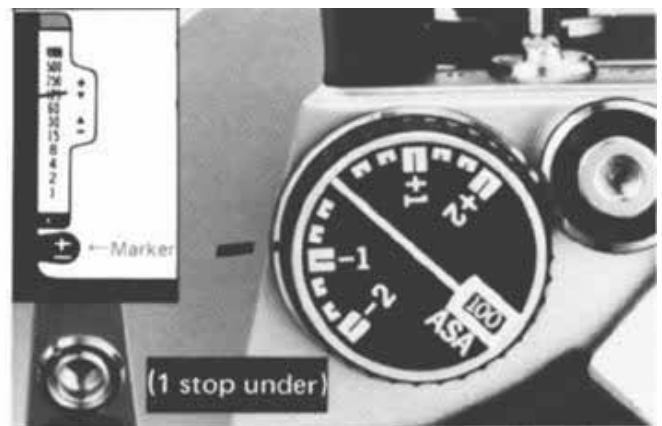

**When taking a picture of a bright subject against a dark background** (spotlighting, deep shadows, etc.), turn the compensation dial **to the (-) side**. Move forward until the subject fills as much of the viewfinder as possible, (with a zoom lens, you may be able to do this by zooming in on the subject without changing your positions). After noting the shutter speed indicated by the meter needle, return to your original position, recompose the picture, and turn the compensation dial until the shutter speed needle indicates the speed obtained from your close-up meter reading.



## EXPOSURE COMPENSATION FOR MANUAL MEASUREMENT

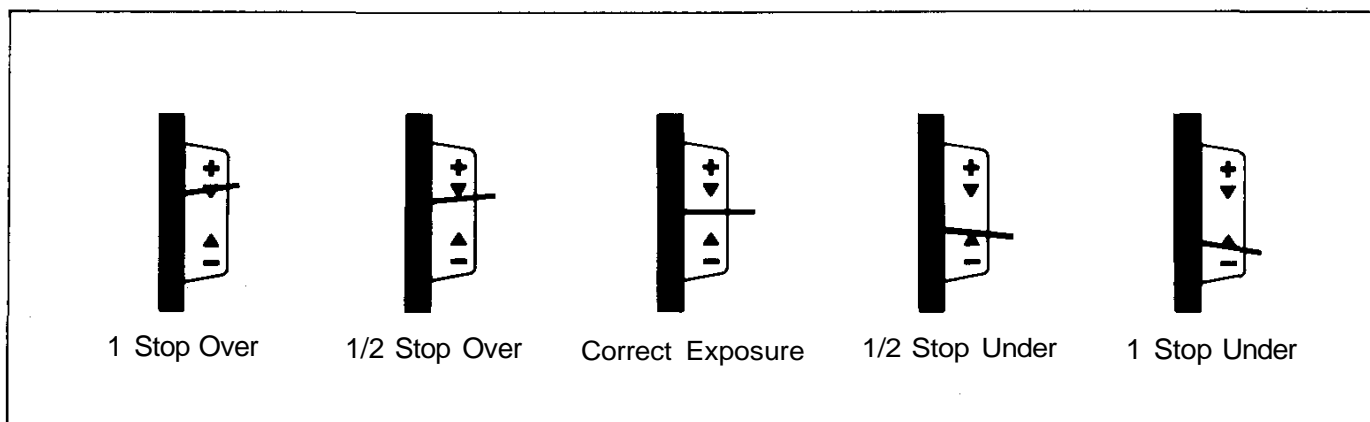

Manual exposure can be compensated by adjusting the F stop or shutter speed. The exposure needle indicates over-exposure at the (+) side, or under-exposure at the (—) side.

### **Dark subject in bright backlighting**

When the most important area of the picture is much darker than the general picture area (strong light hitting the main subject from behind or from the side) the meter will have a tendency to read the brightest part of the picture leaving the main subject under-exposed. To compensate for this, move forward until the subject fills most of the viewfinder picture area and set the F stop/shutter speed combination which centers the meter needle between the index marks. Return to your original

position and take the picture without changing this F stop/shutter speed combination even though the needle is not centered.

**NOTE:** Over-exposure by + 1 stop renders a good result in such a case.

### **Bright subject in dark background**

As previously mentioned, fill the viewfinder picture area with the subject as much as possible, and set correct light measurement. Return to your original position and expose for fine pictures.

**CAUTION:** After taking a picture using the compensation dial, be sure to return the dial to the normal setting

## DEPTH OF FIELD



F16, 1/15 sec.



F2, 1/1000sec.

Depth of field is the area of acceptable sharpness in front of and behind the subject in focus. As you get closer to your subject or as you open your lens (e.g. from F16 to F2.8) the depth of field becomes shallower. By stopping your lens down

(e.g. from F2.8 to F16) or getting farther away from your subject this depth of field can be increased.

The table below shows that when the camera-to-subject distance is 3m, the depth of field at F16 ranges from 1.93m to 6.93m.

As you press the preview button, looking through the viewfinder, you can ascertain the actual depth of field.

Depth of Field Table (F1.8 & F1.450mm Lenses)  
Circle of least confusion 1/30mm

Scale	Camera-to-Subject Distance (m). Figures with * are engraved on the distance scale.										
F Stop	*0.45	*0.5	*0.7	*1	*1.5	*2	*3	*5	*10	*∞	
1.4	0.45 ~0.45	0.50 ~0.50	0.69 ~0.71	0.99 ~1.02	1.47 ~1.54	1.94 ~2.07	2.86 ~3.16	4.61 ~5.46	8.55 12.05	57.78 ~∞	
1.8	0.45 ~0.45	0.50 ~0.50	0.69 ~0.71	0.98 ~1.02	1.46 ~1.55	1.92 ~2.09	2.8 ~3.20	4.52 ~5.60	8.21 12.79	45.05 ~∞	
2	0.45 ~0.45	0.50 ~0.50	0.69 ~0.71	0.98 ~1.02	1.45 ~1.55	1.91 ~2.10	2.80 ~3.23	4.47 ~5.68	8.05 13.20	40.57 ~∞	
2.8	0.45 ~0.45	0.49 ~0.51	0.69 ~0.71	0.97 ~1.03	1.48 ~1.57	1.88 ~2.14	2.73 ~3.33	4.28 ~6.01	7.47 15.15	29.02 ~∞	
4	0.44 ~0.46	0.49 ~0.51	0.68 ~0.72	0.96 ~1.04	1.41 ~1.61	1.83 ~2.20	2.63 ~3.49	4.04 ~6.57	6.74 19.44	20.35 ~∞	
5.6	0.44 ~0.46	0.49 ~0.51	0.67 ~0.73	0.94 ~1.06	1.37 ~1.66	1.77 ~2.29	2.51 ~3.74	3.75 ~7.52	5.96 31.31	14.55 ~∞	
8	0.44 ~0.46	0.48 ~0.52	0.66 ~0.74	0.92 ~1.09	1.32 ~1.73	1.69 ~2.45	2.34 ~4.18	3.39 ~9.61	5.09 378.10	10.21 ~∞	
11	0.43 ~0.47	0.48 ~0.53	0.65 ~0.76	0.90 ~1.13	1.27 ~1.84	1.60 ~2.68	2.21 ~4.91	3.02 14.74	4.30 ~∞	7.44 ~∞	
16	0.43 ~0.48	0.47 ~0.54	0.63 ~0.79	0.86 ~1.20	1.19 ~2.05	1.47 ~3.47	1.93 ~6.93	2.57 138.43	3.42 ~∞	5.13 ~∞	

## DEPTH OF FIELD SCALE

## PREVIEW BUTTON



The double series of numbers engraved on the depth of field scale represents F stops: F4, F8, and F16. Once you have focused on your subject, all objects within the distance range indicated on the lens distance scale between the marks for the F stop you have selected will have acceptable sharpness. For example, in the above picture, the camera-to-subject distance is 3m (10ft.) and the lens is set at F16. If you read the distance scale at the points opposite the engraved "16" on both sides of the reference dot, you will find that the depth of field is from 1.9m (6ft.) to 7m (23ft.).

When you wish to see which objects fall within the acceptable zone of sharpness (depth of field), press the preview button on your lens. The diaphragm of the lens will stop down to the preset F stop enabling you to see the depth of field in the viewfinder.

**CAUTION:** If you jerk the preview button while depressing the shutter release button halfway down the shutter might be released.

## INFRARED PHOTOGRAPHY



The OLYMPUS OM System Lenses are provided with an infrared index mark engraved in red on the depth of field scale.

When shooting with infrared film, focus normally on your subject without the red filter on and read the subject distance on the distance scales. Then, turn the focusing ring to the right until the distance reading is opposite the infrared index mark. Your lens will then be in focus for average infrared photography. Shoot with the red filter on. In the above picture, the red index is set at infinity.

**CAUTION:** Due to special light gathering requirements of infrared films, it is recommended that you follow the film manufacturer's recommendations regarding exposure.

## CAMERA BACK REPLACEMENT



The camera back of the OM-2 is fully interchangeable with the Recordata Back 2, 3 and 250 Film Back 1. To remove the camera back, push down on the release pin as shown. Do not remove the back unless necessary.

The Recordata Back 2, 3 registers data such as date, number, alphabetical code, etc. directly on the picture.

The 250 Film Back 1 is designed for winder or motor drive shooting; it accepts a bulk loaded magazine of 250 frames.

## INTERCHANGEABLE FOCUSING SCREENS

OLYMPUS  
OM-2

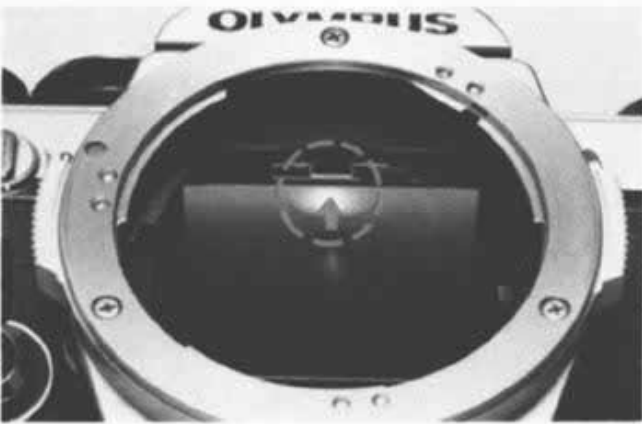

The OM System interchangeable focusing screens provide you with the ultimate in focusing versatility. Optional screens are available to suit virtually every picture-taking situation. The focusing screens come with a special tool. To remove the focusing screen:

- a) Detach the camera lens from the camera body.
- b) Use the special tool provided to push up on the release catch underneath the top ledge of the mirror box (see the photo above). This allows the screen and screen frame to drop down.
- c) Remove the screen from inside the camera by gripping the tip of the screen with the tool as shown.

**CAUTION:** Although the above procedure can be done with fingers, it is recommended that you use the special tool supplied. Changing focusing screens is a procedure to be exercised with great care. Trying to change a screen with your fingers can result in fingerprints and costly damage to the surface of the screen, the prism, or the mirror. Should this occur, cleaning or repair **MUST** be handled by an authorized service center. Such damage is not covered by the product warranty.

- d) To install the screen, fit it into the frame and push the frame upward gently until it clicks into place. Gently shake the camera body to make sure the screen is held securely in place.

## FLASH PHOTOGRAPHY WITH THE T32(or T20) ELECTRONIC FLASH ①



Electronic Flash T32



T32 calculator panel (blank side for TTL "OTF" Auto flash)



Electronic Flash T20



The T32 and T20 are the world's first fully automatic electronic flash units. All their functions are controlled directly by the OM-2 to perform extremely easy, yet highly accurate flash exposures. (See pp. 61~69 for further information on flash units.)

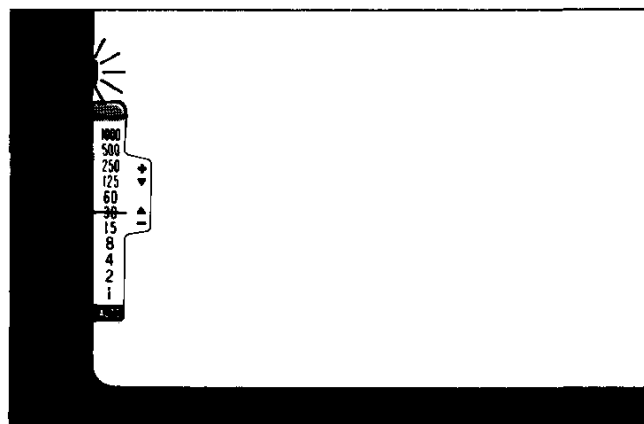

- ① Attach the Accessory Shoe 4 to the OM-2 and mount the T32 (or T20).
- ② Set the camera's selector lever to the "AUTO" position and switch on the T32 (or T20).



- ③ A red lamp lights in the viewfinder when the T32 (or T20) capacitor is charged ready for shooting. Set the aperture ring to the f/stop you require, focus on the subject and release the shutter.  
**NOTE:** All f/stops on the camera lens can be used.

**NOTE:** Mounting the T32 (or T20) on the accessory shoe automatically completes the "X" synchro circuit. It is not necessary to set the X and FP flash selector to "X".

## FLASH PHOTOGRAPHY WITH THE T32 (or T20) ELECTRONIC FLASH ②

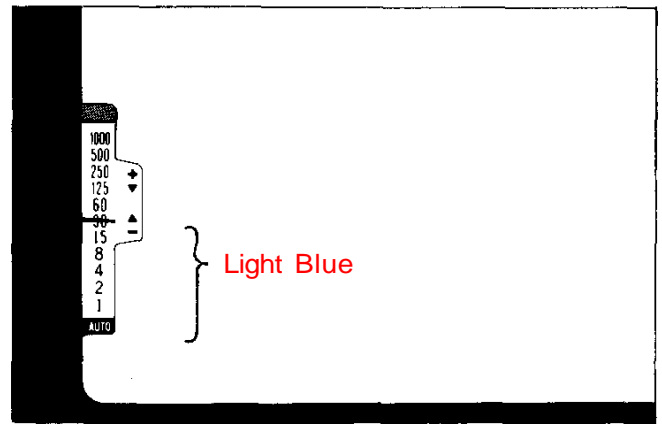
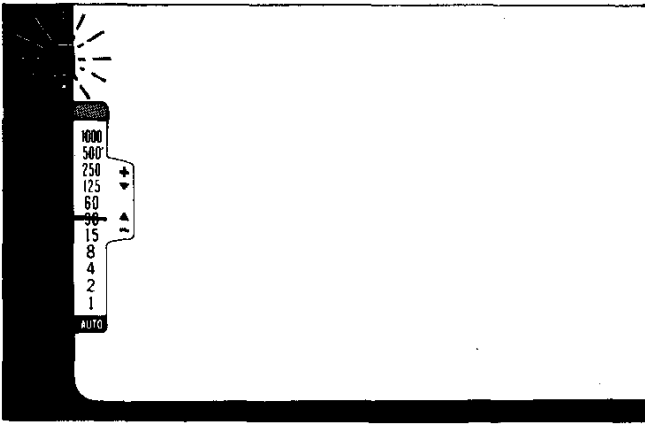

- ④ If the lamp flickers: correct flash exposure has been made.
- If the lamp goes out: flash-to-subject distance is beyond the TTL AUTO working range. Open up the lens stop or move in closer to the subject.
  - If the lamp stays lighted: correct exposure has been made by existing light, requiring no flash.

In case exposure must be achieved by flash illumination, turn the aperture ring until the meter needle points to 1/30 sec. or slower, and shoot.

**NOTE:** The OM-2 incorporates an incorrect flash prevention system. If the shutter speed is faster than the flash synchronizing range, the electronic flash will not fire when you press the shutter release button.



**THE T32(T20)/OM-2 WAY—FLASH PHOTOGRAPHY  
COULDN'T BE SIMPLER AND MORE ACCURATE**

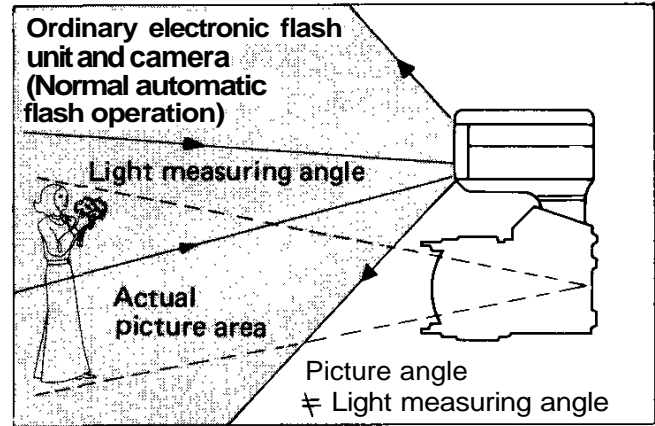
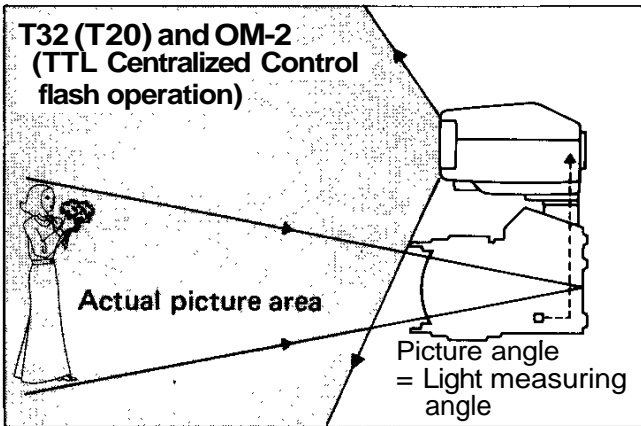

All required of the T32 (T20) is a flick of the on/off switch. The rest is taken care by the OM-2.

- The dial settings required of conventional "auto" flash units — ASA film speed setting, aperture setting, flash mode switching, exposure compensation — are not needed with the T32 (T20).
- Unlike conventional auto flash units which regulate flash emission by an independent light sensor, the T32 (T20) utilizes the OM-2's own built-in SBC light sensors, so that flash acceptance angle always coincides with the picture angle of the camera lens.
- The OM-2 shutter automatically closes at the instant the flash exposure has been completed.

eliminating camera shake. Correct exposure can be confirmed without taking your eye off the viewfinder.

- By the incorporation of an incorrect flash prevention system, the electronic flash will not fire if the shutter speed is faster than the synchronizing range.
- Special techniques such as diffused lighting are made easy, obviating complicated compensations and guesswork.
- Usable flash-to-subject distance range is greatly expanded - from 18cm (F22) to 26m (F1.2) with a guide number of 32 (ASA 100, meters). (From 0.6 ft. to 86 ft. with a guide number of 104 at ASA 100.).

## BOUNCE FLASH



The T32 flash surface can be tilted upward through an angle of 90°, providing easy bounce TTL Auto flash.

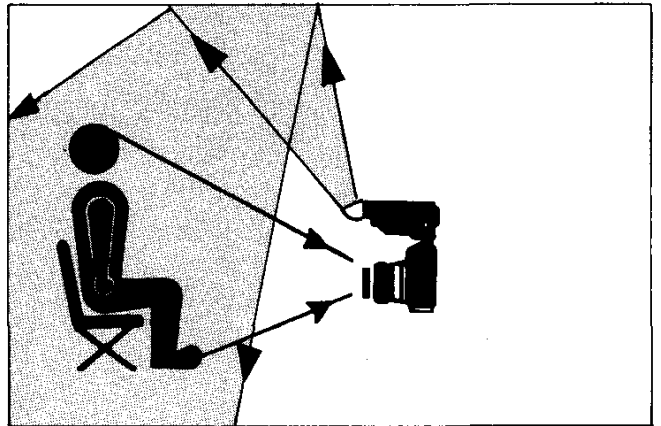

- Point the flash surface at the ceiling so that the subject is illuminated by soft reflected light.

## CLOSE-UP FLASH

OLYMPUS  
OM-2



Close-up in TTL Auto flash can be achieved simply by tilting the flash surface downward (up to 15°).

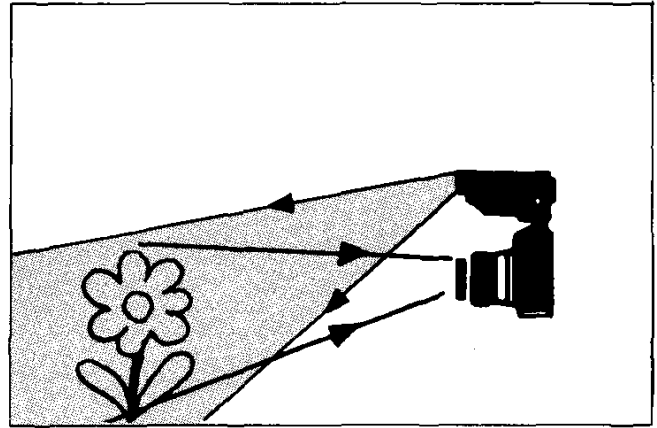

## FLASH PHOTOGRAPHY WITH AN ELECTRONIC FLASH UNIT OTHER THAN THE T32-T20

---

- ① Attach the Accessory Shoe 4 to the OM-2.
- ② Mount the electronic flash on the accessory shoe.  
If your electronic flash unit does not have a direct contact "hot shoe", connect its synchronizing cable to the camera flash socket.
- ③ Set the synchro terminal to "X" by aligning the red dot on the FP and X selector with the "X" indication alongside the flash socket.

**NOTE:** Mounting the electronic flash unit on the accessory shoe automatically completes the "X" synchro circuit. However, there are some flash units which do not fire unless the selector is set to "X".

### [With Quick Auto 310]

- ① The Quick Auto 310/OM-2N (not OM-2) combination cannot perform the TTL ("OTF") Auto flash. Use it in the Normal Auto or Manual flash mode.
- ② Set the camera's selector lever to "MANUAL".

- ③ Set the ASA film speed on the flash unit.
- ④ Set the shutter speed ring to 1/60 sec. or slower.
- ⑤ Set the flash unit to the automatic or manual setting.
- ⑥ Set the desired F stop on the flash unit (in the case of auto mode), and then set the aperture ring to this F stop. In the case of manual mode, F stop can be determined by using the following formula:

$$F \text{ stop} = \frac{\text{flash guide number}}{\text{flash-to-subject distance}}$$

## FLASHBULB PHOTOGRAPHY



- ① Plug the synchronizing cable leading from the flash unit into the camera flash socket, and then attach the flash unit to the camera.
- ② Select the proper synchro setting from the table below according to the type of bulb being used, and align the red dot on the X and FP flash selector with the "X" or "FP" indication alongside the flash socket.
- ③ Select the proper shutter speed from the table below, and set the shutter speed ring accordingly.
- ④ Determine the correct F stop for flash exposure by using the calculator dial, exposure chart or guide number formula. Set the aperture ring to this F stop.

**CAUTION:** With the clip-on type "FP" class flash unit, the synchronizing cable must be used to connect the unit and the camera.

■ The table indicates proper synchronization speeds for most flash equipment.

Terminal	Flash Lamp	Shutter Speed										
		1000	500	250	125	60	30	15	8	4	2	1
FP	FP	○	○	○	○	○	*	*	*	*	*	*
X	Electronic Flash					○	○	○	○	○	○	○
	MF						*	○	○	○	○	○
	M · F P							○	○	○	○	○

○ = Recommended; \* = Not recommended due to bulb quality

## MOTOR DRIVE PHOTOGRAPHY ①



### Motor Drive 1

The standard motor drive unit forms the heart of the Motor Drive Group. An extremely high-performance unit capable of high-speed sequence shooting at 5 frames per second, operating off various power units. Can be switched to the "single" mode of operation, winding film at a high speed of 0.16 second per frame.





■ **Attaching the Motor Drive 1**

- ① Remove the motor drive socket cap from the camera base plate.
- ② Insert the motor drive guide pin into the guide pin hole on the camera base plate. Turn the clamping screw clockwise until the Motor Drive 1 is securely attached to the camera base plate.



■ **Attaching the M. 18V Control Grip 1**

- ① Remove the M.18V Battery Holder 1, insert twelve 1.5V penlight (AA) size batteries into the battery holder, and re-insert the battery holder into the Control Grip.
- ② Align the red index line, and push the control grip forward until it snaps into the front of the motor drive.

**NOTE:** A flat-type rechargeable power source, the M. 1.5V Ni-Cd Control Pack 1, is also available.

## MOTOR DRIVE PHOTOGRAPHY ②

---



### ■ Photography with the Motor Drive Units Using the M. 18V Control Grip 1

- ① Unlock the shutter release lock lever on the Control Grip.
- ② Turn the mode selector on the Control Grip to either "SINGLE" or "SEQUENCE". Set the mode selector to the "OFF" position when the Motor Drive 1 is not in use.

**NOTE:** In either mode, automatic exposure control is possible in the full range of shutter speeds, and manual exposure is possible from 1 second to 1/1000 second.

- ③ Release the shutter.

**NOTE:** You may use either the shutter release on the Control Grip 1 or the shutter release on the Motor Drive 1 to trigger the shutter.



## WINDER 2 OPERATION ①



### Winder 2

The unit provides the OM cameras with automatic film winding capability for single-frame as well as sequential filming (max. 2.5 frames per second).



## WINDER 2 OPERATION ②

---



### Attaching the Winder 2

- ① Remove the motor drive socket cap.
- ② Pull up and rotate the mode selector to the "OFF" position.
- ③ Remove the M. 6V Battery Holder 1 from inside the winder, insert four 1.5V penlight (AA) size batteries into the battery holder, and put it back into the compartment. Insert the guide pin into the guide pin hole on the camera base plate. Turn the clamping screw clockwise until the Winder 2 is securely attached to the camera base plate.



### Taking the pictures

- ① Pull up and rotate the mode selector to the "SINGLE" or "SEQUENCE" position.
- ② Press the shutter release.

**NOTE:** The removed motor drive cap can be stored in the socket cap storage positioned on the underside of the battery holder compartment.

## CARE AND STORAGE



### General

- Dust and moisture are harmful agents affecting your camera. Remove the camera from the case and store it in a dry, well-ventilated place making sure the shutter and self-timer are free from tension. Do not store the camera near moth balls or similar volatile chemical materials to avoid the possibility of damage to metal surfaces.
- When storing the camera for a long period of time, remove the battery. Wipe battery surfaces with a dry cotton cloth before re-inserting into the camera.
- Avoid dropping or hitting the camera.
- Never store the camera where temperatures exceed 50°C (122°F). When you use the camera in temperatures under —20°C (—4°F), it may sometimes fail to operate properly. To avoid this, warm the camera before use. Protect against excess moisture by using packs of silica gel or other desiccant in the storage area.
- After use near the ocean, wipe the camera surfaces clean with a soft cloth; never leave salt on the camera. (Salt may be airborne near the ocean and collect on the camera even though it has not been in direct contact with water.)
- Avoid excessive tightening when mounting on a tripod.

- 
- Avoid areas exposed to corrosive chemicals, radios, TV sets, or magnets.
  - Have all repairs performed by an authorized OLYMPUS Service Center. You may send it through the store where you bought your camera or directly to an Olympus Service Center.

#### **Parts**

- Do not press the shutter release button at random.
  - Do not touch any part that moves at high speed such as the shutter, instant return mirror, diaphragm, etc.
- Avoid touching the surfaces of the lens. Clean only with an air blower, antistatic brush, or wipe it lightly with a camel hair brush or lens tissue. In EXTREME cases, use a clean, soft cotton cloth moistened with denatured alcohol. NEVER rub the lens surfaces with your finger, clothing, or other abrasive material.
  - If dust or fingerprints collect on the mirror, focusing screen, or prism, take the camera to an authorized OLYMPUS Service Center. It needs professional attention.

## QUESTIONS & ANSWERS



**Q: My camera is loaded with film. Why doesn't the rewind knob rotate when I advance the film?**

A: The film leader may not be inserted in the film take-up spool and the film is not advancing. (See page 9.)

**Q: Why can't I advance the film?**

A: The shutter may be cocked and ready to fire. Try pressing the shutter release button. (See page 10.)

Or, the film may be fully exposed. Check the exposure counter. If you feel tension on the film advance lever, DO NOT FORCE IT. Rewind the film. (See page 20.) Or the self-timer lever is not securely in its upright position, reset and release the self-timer. (See page 21.)

**Q: Why won't the shutter release button move when I press it?**

A: The film advance lever may not have been fully advanced. (See page 9.)

**Q: I can't advance the film nor release the shutter, and the viewfinder is totally dark. Why?**

A: The mirror is locked up because the batteries are depleted or the film was advanced in the middle of an automatic exposure. Press the selector lever to the "CHECK•RESET" position to unlock the mirror. (See page 8.) Two batteries should be replaced as a pair if they are depleted.

**Q: Why won't the rewind crank turn when I try to rewind the film?**

A: The rewind release lever may not be rotated in the arrow direction until it aligns with the "OM-2" marking. (See page 20.)

**Q: Why can't I set the ASA film speed I need?**

A: At the most, 3 stops can be advanced in a single stroke of the dial. If you require more stops, lift up and rotate the outer collar of the dial until it stops; then release the collar and reverse the collar and dial together until the white line is aligned with the black index on the pentaprism. Repeat this procedure until you reach the ASA speed you need. (See page 11.)

---

**Q: What batteries should I use?**

A: Use two 1.5V silver oxide batteries SR44 (Eveready EPX-76 or equivalents). Never use 1.3V mercury batteries (though they are the same size). (See page 7.)

**Q: Why doesn't the battery chamber cap fit?**

A: If you also own an OM-1, you may have the caps mixed up. Although they look alike, the OM-2 cap has "2" engraved inside.

**Q: When should I check the batteries?**

A: (1) When new batteries are inserted. (2) After the camera hasn't been used for a long time. (3) Before beginning a prolonged period of use.

**Q: Can film be properly exposed when the selector lever is in the "OFF" position?**

A: The OM-2 is designed to always expose the film 1/30 second or faster (ASA 100) with the selector lever at the OFF position. If the shutter is unintentionally released in darker condition on "OFF" mode, the exposure automatically stops in approx. 1/30 second (ASA 100) to save unnecessary battery exhaustion.

**Q: Can I set the shutter speed ring to any position to take pictures on AUTO mode?**

A: Any position except "B".

**Q: Why is the automatic exposure shutter speed much longer than indicated by the meter in the viewfinder?**

A: If film is not loaded, the shutter speed is much longer than that indicated. If it is necessary to obtain a correct reading without actually taking a picture, insert a waste, undeveloped film or the paper you find behind the camera back at the purchase of your OM-2, into the film position in the camera.

**Q: Can I use the exposure compensation dial when the selector lever is set at the "MANUAL" position?**

A: Yes. If the exposure compensation dial is set for an intentional over- or under-exposure, that over- or under-exposure will be achieved when the shutter speed/F stop combination centers the meter needle between the over- and under-exposure index marks in the viewfinder. (See page 24.)

**Q: How can I remove dust from inside the viewfinder?**

A: After detaching the Focusing Screen, blow away any dust with an air blower. Never wipe the screen surface with cloth or paper. (See page 28.) If this does not solve the problem, send your camera to an authorized OLYMPUS Service Center.

**Q: Is it normal for the microprism in the center of the viewfinder to "shimmer" and darken?**

A: Yes, when a lens with a maximum aperture smaller than F5.6 is mounted on the camera. It also happens with other lenses when the depth of field preview button is pressed.

**Q: Why does the self-timer stop halfway without releasing the shutter?**

A: The lever will stop without releasing the shutter if the film has not been fully advanced. Reset the self-timer and make sure the film is fully advanced. The self-timer lever moves freely because you forget to turn the start lever after you set the self-timer lever. (See page 21.)

**Q: Can I operate the camera without the motor drive socket cap in place?**

A: No. Light will enter the camera body through this hole, fogging the film. Also, dust and dirt may enter, causing a camera malfunction.

**Q: Why doesn't my electronic flash unit fire when I release the shutter?**

A: If the shutter speed is 1 /125 second or faster in conjunction with the electronic flash T32 or T20, the built-in incorrect flash prevention system does not permit flashing. Confirm the shutter speed. (See page 31.)

**Q: Why do I feel a small electrical shock when I touch the terminal contact of the accessory shoe?**

A: This is normal when using a side-mounting type flash. When using flash that is not connected to the accessory shoe, remove or cover the shoe.

## THE MOST IMPORTANT FEATURE OF THE OM-2-TTL DIRECT(OTF)LIGHT MEASURING

Diagram of light path in conventional SLRs

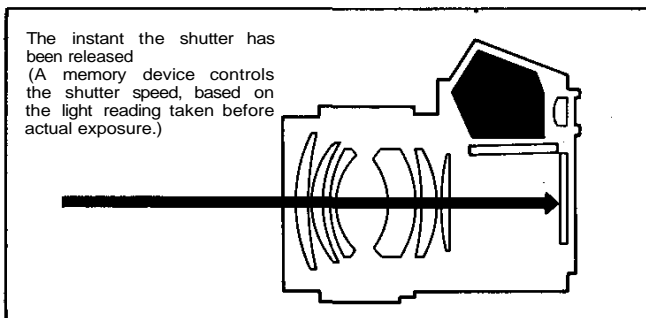
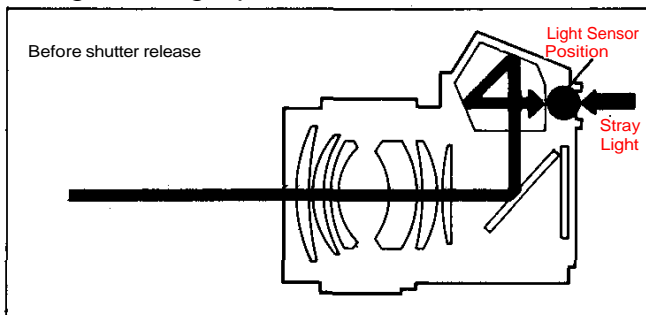

In the automatic mode, the OM-2 measures the subject brightness very differently from any other automatic camera — faster and with much more accuracy. With the OM-2, light entering the lens is measured directly at the film plane by the sen-

Diagram of light path in OM-2

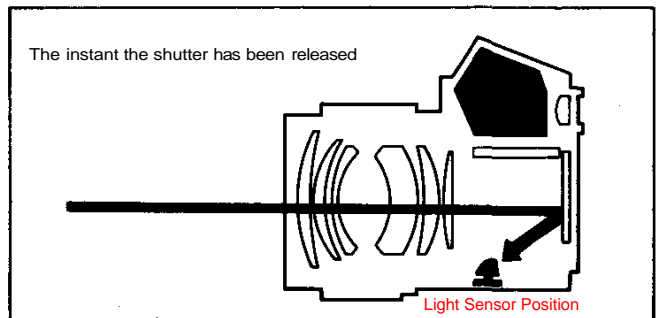
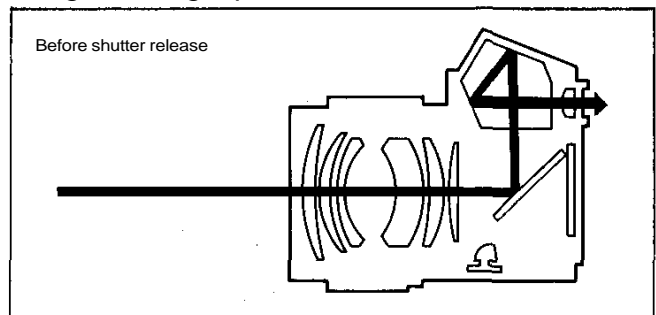

sors at the precise moment the film is being exposed. When sufficient light has reached the film, the electronic brain senses the information and instantly closes the shutter.



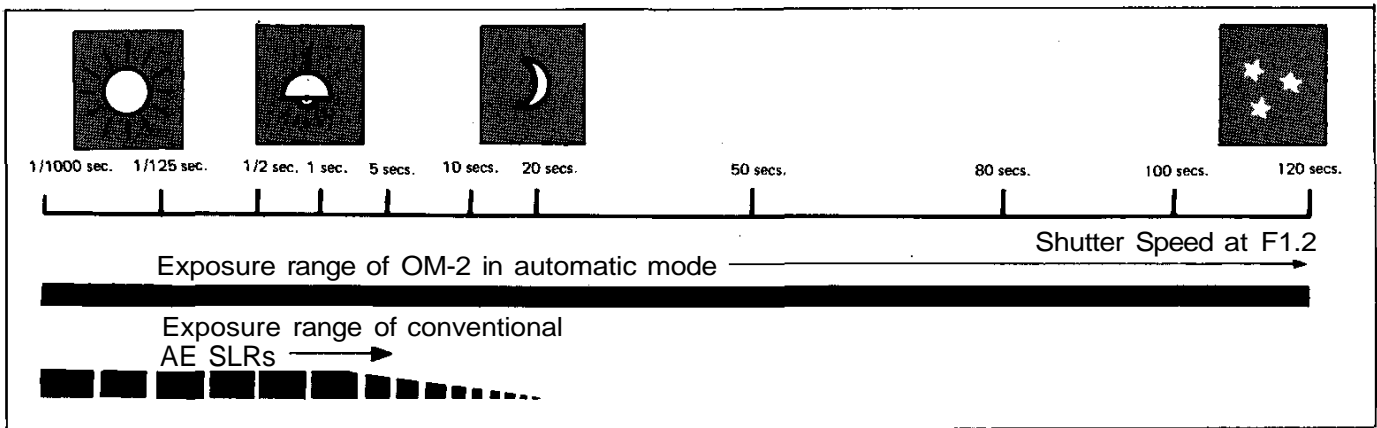

**Advantageous Points of Through-The-Lens Direct (off-the-film) Light Measuring Method**

1. The OM-2 sensors respond instantly to changes in the light during exposure and feed back the information to the shutter control mechanism.
2. The sensors measure flash intensity as it builds up and cut off its light at the source when the correct exposure level is reached. (TTL Centralized Control Flash)
3. Even during 5-frame-per-second motor drive operation, this Method insures correct exposure for each frame individually.
4. The Method operates accurately in far dimmer light than other systems. ASA 100 film can

5. The Method excludes all possibilities of stray light leaking through the camera eyepiece and affecting the exposure reading.
6. The Method gives correct exposures even when the clear-field type focusing screen is in use.



The OM System is comprehensively arrayed to meet an ever-expanding universe of photographic conditions for any subjects from the stars to micro-organisms.

A full-scale system camera is distinguishable by some of the prerequisite characteristics as broadly mentioned below:

- Interchangeability of focusing screens.
- Adaptability to high speed motor drive photography.
- A wide range of high quality system components, including interchangeable lenses.
- Compatibility of the camera body with an electronic flash unit allowing high technic flash photography with extreme ease and accuracy.
- Tough and reliable shutter, viewfinder, etc. that withstand harsh handling without failing.

When these exacting conditions have been satisfied, an OM-2 is born as a true system camera that controls an entire SLR comprehensive system. The OM-2 is backed up with over 300 components systematically organized under eight groups — Interchangeable Lens, Finder, Flash, Motor Drive, Phototechnical, Macrophoto, Photomicro and Case.

## ZUIKO INTERCHANGEABLE LENS GROUP

---



One of many advantages of the single lens reflex camera is the large variety of interchangeable lenses available. The Zuiko Interchangeable Lens Group (designed and manufactured by Olympus) comprises 33 lenses. Zuiko lenses have always enjoyed a high reputation in photographic circles — the most modern design technology and employment of newly developed optical glass have made possible a new series of innovative, high performance lenses. These lenses have a host of special features including new construction that compensates for close focus aberrations, increased aperture ratio in the wide angle lenses, and reduction in telephoto lens size and weight. The OM System adopts 49mm filters for most lenses from 21mm to 200mm. As part of the OM System design all the lenses now offer higher performance in small configurations. Olympus has produced lenses for microscopes for decades and the new Zuiko lenses benefit from this scientific experience. See the "OM System Zuiko Interchangeable Lenses" manual for further information.



## TABLE OF INTERCHANGEABLE LENSES

TYPE	INTERCHANGEABLE LENSES	ANGLE OF VIEW	OPTICAL CONSTRUCTION ELEMENT-GROUP	DIA-PHRAGM	F STOP RANGE	MIN. FOCUS (meters) (ft.)	MIN. FIELD	WEIGHT (oz.)
FISHEYE	ZUIKO FISHEYE 8mm F2.8	180°(circle)	11-7	AUTO.	2.8-22	0.2 m (0.7)		640g(22.6)
	ZUIKO FISHEYE 16mm F3.5	180°	11-8	AUTO.	3.5-22	0.2 m (0.7)		180g (6.3)
SUPER WIDE	ZUIKO MC 18mm F3.5	100°	11-9	AUTO.	3.5-16	0.25m ( 0.8)Ⓢ	30x20cm	250g (8.8)
	ZUIKO MC 21mm F2	92°	11-9	AUTO.	2-16	0.2 m ( 0.8)Ⓢ	21x14cm	250g (8.8)
	ZUIKO 21mm F3.5	92°	7-7	AUTO.	3.5 16	0.2 m (0.7)	21x14cm	180g(6.3)
	ZUIKO MC 24mm F2	84°	10-8	AUTO.	2-16	0.25m ( 0.8)Ⓢ	23x15cm	280g (9.9)
	ZUIKO 24mm F2.8	84°	8-7	AUTO.	2.8-16	0.25m (0.8)	23x15cm	180g(6.3)
WIDE	ZUIKO MC 28mm F2	75°	9-8	AUTO.	2-16	0.3 m ( 1.0)Ⓢ	27x18cm	250g (8.8)
	ZUIKO 28mm F3.5	75°	7-7	AUTO.	3.5-16	0.3 m (1.0)	27x18cm	180g (6.3)
	ZUIKO MC 35mm F2	63°	8-7	AUTO.	2-16	0.3 m (1.0)	21x14cm	240g (8.5)
	ZUIKO 35mm F2.8	63°	7-7	AUTO.	2.8-16	0.3 m (1.0)	21x14cm	180g(6.3)
	ZUIKO SHIFT 35mm F2.8	63° (83° at max shift)	8-6	MANUAL	2.8-22	0.3 m (1.0)	21x14cm	310g(10.9)
STANDARD	ZUIKO 55mm F1.2	43°	7-7	AUTO.	1.2-16	0.45m (1.5)	23x15cm	310g(10.9)
	ZUIKO MC 50mm F1.4	47°	7-6	AUTO.	1.4-16	0.45m (1.5)	24x16cm	230g (3.1)
	ZUIKO 50mm F1.8	47°	6-5	AUTO.	1.8-16	0.45m (1.5)	24x16cm	170g (6.0)
	ZUIKO MC MACRO 50mm F3.5	47°	5-4	AUTO.	3.5-22	0.23m ( 0.8)Ⓢ	72x48cm	200g (7.1)
ZOOM	ZUIKO MC ZOOM 35-70mm F3.6	64° ~ 34°	10-8	AUTO.	3.6-22	0.8 m (2.7)	72x43cm~25x37.5cm	420g(14.8)
	ZUIKO ZOOM 75-150mm F4	32° ~ 16°	15-11	AUTO.	4-22	1.6 m (5.2)	64x42cm~32x21cm	440g(15.5)
	ZUIKO MC ZOOM 85-250mm F5	29° ~ 10°	15-11	AUTO.	5-32	2 m (6.0)	66x44cm~23x15cm	890g(31.4)
TELEPHOTO	ZUIKO MC 85mm F2	29°	5-4	AUTO.	2-16	0.85m (2.8)Ⓢ	29x19cm	260g (9.5)
	ZUIKO 100mm F2.8	24°	5-5	AUTO.	2.8-22	1 m (3.3)	29x19cm	230g (8.1)
	ZUIKO MC 135mm F2.8	18°	5-5	AUTO.	2.8-22	1.5 m (4.9)	32x21cm	360g(12.7)
	ZUIKO 135mm F3.5	18°	5-4	AUTO.	3.5-22	1.5 m (4.9)	32x21cm	290g(10.2)
	ZUIKO MC 180mm F2.8	14°	5-5	AUTO.	2.8-32	2 m (6.0)	32x21cm	700g(24.7)
	ZUIKO MC 200mm F4	12°	5-4	AUTO.	4-32	2.5 m (8.2)	36x24cm	510g(18.0)
SUPER TELEPHOTO	ZUIKO 200mm F5	12°	6-5	AUTO.	5-32	2.5 m (8.2)	36x24cm	380g(13.4)
	ZUIKO 300mm F4.5	8°	6-4	AUTO.	4.5-32	3.5 m (11.5)	33x22cm	1100g(38.8)
	ZUIKO MC 400mm F6.3	6°	5-5	AUTO.	6.3-32	5 m (16.4)	36x24cm	1300g(46.0)
	ZUIKO MC 600mm F6.5	4°	6-4	AUTO.	6.5-32	11 m (36.1)	55x37cm	2800g(98.8)
	ZUIKO MC 1000mm F11	2.5°	5-5	AUTO.	11-45	30 m (98.4)	98x65cm	4000g(141.0)
SPECIALUSE	ZUIKO MC MACRO 20mm F3.5	9° at highest mag.	4-3	MANUAL	3.5-16	W/Auto Bellows & PM-MT ob	max. 8 x 5 mm min. 3 x 2 mm	70g (2.5)
	ZUIKO MC MACRO 38mm F3.5	9° at highest mag.	5-4	MANUAL	3.5-16	W/Auto Bellows & PM-MT ob	max. 20 x 13mm min. 6 x 4 mm	90g (3.2)
	ZUIKO MC 1:1 MACRO 80mm F4	9° at highest mag.	6-4	AUTO.	4-32	W/Auto Bellows or 65-116	max. 72 x 48mm min. 18 x 12mm	170g (6.0)
	ZUIKO MC MACRO 135mm F4.5	18°	5-4	AUTO.	4.5-45	W/Auto Bellows or 65-116	72x48mm	320g(11.3)

MC stands for multicoating.

Ⓢ Automatic correction design against close distance aberrations.





LENGTH	MAX. DIAMETER	HOOD	FILTER	1-1	1-2	1-3	1-4	1-5	1-6	1-7	1-8	1-9	1-10	1-11	1-12	1-13	1-14
				Micro-matte type	Micro-matte type	Split-matte type	All-matte type	Micro-clear field type	Micro-clear field type	Micro-clear field type	All-matte type	Clear field type	Checker-matte type	Cross-hairs-matte	Cross-hairs-clear	Micro-split-matte	Micro-split-matte
82mm	102mm	—	Built-in	Compatible	Compatible	Compatible	Compatible	Compatible					Compatible	Compatible	Compatible	Compatible	Compatible
31mm	59mm	—	Built-in	Compatible	*	Compatible	Compatible	Compatible					Compatible	Compatible	Compatible	Compatible	Compatible
42mm	62mm	49→72mm Screw-in	72mm	Compatible	*	Compatible	Compatible	Compatible					Compatible	Compatible	Compatible	Compatible	Compatible
43.5mm	60mm	55mm Slide-on	55mm	Compatible	*	Compatible	Compatible	Compatible					Compatible	Compatible	Compatible	Compatible	Compatible
31mm	59mm	49mm Screw-in	49mm	Compatible	*	Compatible	Compatible	Compatible					Compatible	Compatible	Compatible	Compatible	Compatible
48mm	60mm	55mm Screw-in	55mm	Compatible	*	Compatible	Compatible	Compatible					Compatible	Compatible	Compatible	Compatible	Compatible
31mm	59mm	49mm Screw-in	49mm	Compatible	*	Compatible	Compatible	Compatible					Compatible	Compatible	Compatible	Compatible	Compatible
43mm	60mm	49mm Screw-in	49mm	Compatible	*	Compatible	Compatible	Compatible					Compatible	Compatible	Compatible	Compatible	Compatible
31mm	59mm	49mm Screw-in	49mm	Compatible	*	Compatible	Compatible	Compatible					Compatible	Compatible	Compatible	Compatible	Compatible
42mm	60mm	55mm Screw-in	55mm	Compatible	*	Compatible	Compatible	Compatible					Compatible	Compatible	Compatible	Compatible	Compatible
33mm	59mm	51mm Slide-on	49mm	Compatible	*	Compatible	Compatible	Compatible					Compatible	Compatible	Compatible	Compatible	Compatible
58mm	68mm	49mm Slide-on	49mm	*	*	*	Compatible	Compatible					Compatible	Compatible	Compatible	*	*
47mm	65mm	57mm Slide-on	55mm	Compatible	Compatible	Compatible	Compatible	Compatible					Compatible	Compatible	Compatible	Compatible	Compatible
39mm	60mm	51mm Slide-on	49mm	Compatible	Compatible	Compatible	Compatible	Compatible					Compatible	Compatible	Compatible	Compatible	Compatible
31mm	59mm	51mm Slide-on	49mm	Compatible	Compatible	Compatible	Compatible	Compatible					Compatible	Compatible	Compatible	Compatible	Compatible
40mm	60mm	—	49mm	Compatible	Compatible	Compatible	Compatible	Compatible					Compatible	Compatible	Compatible	Compatible	Compatible
74mm	67mm	60mm Slide-on	55mm	Compatible	Compatible	Compatible	Compatible	Compatible					Compatible	Compatible	Compatible	Compatible	Compatible
115mm	63mm	Built-in	49mm	Compatible	Compatible	Compatible	Compatible	Compatible					Compatible	Compatible	Compatible	Compatible	Compatible
196mm	70mm	Built-in	55mm	Compatible	Compatible	Compatible	Compatible	Compatible					Compatible	Compatible	Compatible	Compatible	Compatible
48mm	60mm	49mm Screw-in	49mm	Compatible	Compatible	Compatible	Compatible	Compatible					Compatible	Compatible	Compatible	Compatible	Compatible
48mm	50mm	49mm Screw-in	49mm	Compatible	Compatible	Compatible	Compatible	Compatible					Compatible	Compatible	Compatible	Compatible	Compatible
80mm	61mm	Built-in	55mm	Compatible	Compatible	Compatible	Compatible	Compatible					Compatible	Compatible	Compatible	Compatible	Compatible
73mm	60mm	Built-in	49mm	Compatible	Compatible	Compatible	Compatible	Compatible					Compatible	Compatible	Compatible	Compatible	Compatible
124mm	80mm	Built-in	72mm	Compatible	Compatible	Compatible	Compatible	Compatible					Compatible	Compatible	Compatible	Compatible	Compatible
127mm	67mm	Built in	55mm	Compatible	Compatible	Compatible	Compatible	Compatible					Compatible	Compatible	Compatible	Compatible	Compatible
105mm	62mm	Built-in	49mm	Compatible	Compatible	Compatible	Compatible	Compatible					Compatible	Compatible	Compatible	Compatible	Compatible
181mm	80mm	Built-in	72mm	Compatible	Compatible	Compatible	Compatible	Compatible					Compatible	Compatible	Compatible	Compatible	Compatible
255mm	80mm	Built-in	72mm	*	Compatible	*	Compatible	Compatible					Compatible	Compatible	Compatible	*	*
377mm	110mm	Built-in	100mm	*	Compatible	*	Compatible	Compatible					Compatible	Compatible	Compatible	*	*
662mm	110mm	Built-in	100mm	*	*	*	Compatible	Compatible					Compatible	Compatible	Compatible	*	*
20mm	32mm	—	21mm Slide-on	*	*	*	*	Compatible					*	*	Compatible	*	*
28mm	43mm	—	32mm Slide-on	*	*	*	*	Compatible					*	*	Compatible	*	*
33mm	59mm	—	49mm	*	*	*	*	Compatible					*	*	Compatible	*	*
47mm	60mm	57mm Slide-on	55mm	*	*	*	*	Compatible					*	*	Compatible	*	*

Compatible : The meter needle indicates correct light readings. In the combination marked with \*, micro-prism, split-prism and edges of the finder will darken.

Compatible: The meter in the OM-1 and OM-2 (on MANUAL) cannot be used. On AUTO, the OM-2 makes correct exposures, but the meter needle does not indicate correct shutter speeds.

(Specifications subject to change without notice.)

## INTERCHANGEABLE LENS GROUP UNITS

---

### ■ Lens Hoods

Lens hoods protect against extraneous light striking the lens and causing unwanted glare. Hoods for standard lenses are cover types and can be reversed to provide easy storage even when the camera is in the case. Five lens hoods are optionally available (see TABLE OF INTERCHANGEABLE LENSES on pp. 53-54).

### ■ Camera Body Cap

#### ■ Rear Lens Cap

#### ■ Front Lens Caps

(49mm, 55mm, 72mm and 100mm in diameter)

#### ■ Adapter Ring 49 → 72mm

A lens hood/filter mount for the 18mm F3.5 lens.

### ■ Filters

Filters are essential to the effective rendition of photographic subjects. In controlling contrast and eliminating unwanted haze in black and white photography, the use of the correct filter often means the difference between a good photograph and a great one. In color, where the balancing of the light with the film emulsion is absolutely necessary for correct color, conversion and light balancing filters are the only effective way of achieving the desired results.

\* Be careful not to use two filters simultaneously in order to avoid unintentional cut in the periphery of a photograph. (See the table of various filters on the opposite page.)







Application	Name	Color	Description	Diameter			
				49mm	55mm	72mm	100mm
B. & W. and Color	Skylight (1A)	Colorless	Similar to UV filter. Eliminates ultraviolet rays. Reduces haze and bluish tones in daylight photography. Effective with color film only. May be used at all times to protect the lens.	○	○	○	○
	L39 (UV)	Colorless	Eliminates undesirable ultraviolet rays which cause dull, flat pictures. Renders subject in clear detailed brilliance. May be used at all times to protect the lens.	○	○	○	○
	ND2 ND4	Grey Grey	Reduces the quantity of light entering the lens to 1/2 or 1/4 of the original intensity. For use in extremely bright conditions when you wish to maintain a wide aperture.	○	○	—	—
	Polarizing filter POL	—	Enables you to take pictures through glass or water without reflections. Will darken the sky in black-and-white photographs without altering other color values in the picture, and renders blue skies darker when used with color film. Reflections are reduced to provide better texture surface detail.	○	○	—	—
B. & W.	Y48 (Y2)	Yellow	Accentuates contrast, darkens blue skies. Very effective in daylight scenes where the sky is part of subject matter. Heightens the effect of white clouds. Useful in copying documents where line copy is blue or black on light background.	○	○	○	○
	O56 (O2)	Orange	Absorbs a wider range of wavelengths from UV to dark green than the Y2. Makes a superb rendition of the texture of outdoor subjects, and indoors. It brings out detail in objects yellow, brown. Used with infrared film.	○	○	○	○
	R6CMR1)	Red	Used as contrast filter to create darkened sky or in copying. Also used to penetrate haze in landscape photography for stronger contrast than an O2 filter. Used with infrared film.	○	○	○	○
Color	A4 (81C)	Amber	For use when taking color pictures in cloudy or rainy weather. Reduces bluish tone.	○	○	—	—
	B4 (82C)	Blue	Designed for use when taking color pictures in early morning or late evening hours when red rays are predominant.	○	○	—	—

## FINDER GROUP

---



The viewfinder is one of the most important features of a single lens reflex camera. Since every photographic subject is turned into a visual image by means of the finder, a finder that is dark or difficult to look through is an obstacle to good photography. However enriched an SLR camera is with a wide range of interchangeable lenses, the SLR cannot be expected to fulfill its essential function without the provision for changing of focusing screens. The OM-2 is provided with a viewfinder that offers a far brighter, large image than previous 35mm SLR cameras. The Finder Group supplements this basic advantage with a comprehensive set of 14 focusing screens for a wide variety of applications from photomicrography to astrophotography. Unless the most suitable focusing screen for a given photographic purpose is available, the potentialities of a system camera cannot be utilized. For fast, accurate focusing, the OM System Finder Group offers the unique Vari-magni Finder with a magnification selector, the Eyecup 1 that accepts a variety of Dioptic Correction Lenses, Eyecoupler, etc.

## FINDER GROUP UNITS



### ■ Varimagni Finder

This unique and exclusive unit for the OM System combines the two functions of angle finder and magnifier, incorporating 9 lens elements and a reflector. It fits over the camera's eyepiece, and can be adjusted for individual eyesight. Its eyepiece tube is rotatable through 360°, for



use in low level and 90° angled shots. The two-stage, one-touch switching system offers both a 1.2x magnification image covering the whole screen, and a 2.5x enlargement of the central portion for critical focusing. For photomicrographic use, insert the Eyecoupler between the camera and Varimagni Finder.

### ■ Eyecup 1

Attached by sliding over the OM Body eyepiece. Its rubber hood prevents stray light from entering through the eyepiece, an essential requirement in light measuring. The Eyecup 1 is provided with a slot for Dioptic Correction Lenses.



### ■ Eyecoupler

Connects the Varimagni Finder to the OM Body for photomicro-micrography. It also ensures full coverage of the bright viewfinder field for use of the Eyecup 1 in conjunction with the Motor Drive 250 Film Back.

### ■ Focusing Screen 1

Interchangeable Focusing Screens are often thought of as a luxury feature in 35mm photography. Yet the Standard Focusing Screen 1-13 is often inconvenient

or difficult to use, and, in some circumstances it is quite unsatisfactory. With super-telephoto lenses for instance, the micro-prism becomes excessively dark. With the high magnifications of macrophotography and photomicrography, it is impossible to focus.







The feature of each Focusing Screen is listed on pp. 59—60.



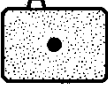

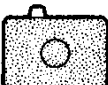



### ■ Dioptic Correction Lens 1

Available in 8 diopter corrections: +2, +1, 0 (for hypermetropia); -1, -2, -3, -4, -5 (for myopia). Used to match the photographer's vision, and especially necessary in fine focusing for high magnification. Fits into the Eyecup 1.

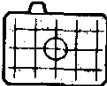
## FINDER GROUP UNITS

TYPE	SCREEN	FEATURES
<b>1-1</b> <b>Microprism-matte</b> <b>type</b> (for most lenses)		Standard type, suitable for general photography. Fast and accurate focusing is done on the central microprism spot as well as on the surrounding matte area. When a lens with a maximum speed of F5.6 or slower is used, the microprism darkens and focusing must be made on the matte area. The meter needle indicates proper exposures.
<b>1-2</b> <b>Microprism-matte</b> <b>type</b> (for standard & telephoto lenses)		Suitable for general photography in conjunction with a standard or telephoto lens. Focusing is done on the microprism spot as well as on the matte area. When a lens with a maximum speed of F8 or slower is used, the microprism spot darkens. The meter needle indicates proper exposures.
<b>1-3</b> <b>Split image-matte</b> <b>type</b> (for most lenses)		Suitable for general photography ensuring critical focusing, and ideal for photographers who prefer the split-field and coincidence type focusing. When a lens with a maximum speed of F8 or slower is used, the split prism darkens. The meter needle indicates proper exposures.
<b>1-4</b> <b>All matte type</b> (for most lenses)		Suitable for general photography and ideal for photographers who prefer a view field free from microprism or split prism and for those who are accustomed to focus using matte area. Also suitable for super telephoto photography and close-up photography in conjunction with macro lenses and Auto Bellows. The meter needle indicates proper exposures.
<b>1-5</b> <b>Microprism-clear</b> <b>field type</b> (for wide angle & standard lenses)		This transparent screen provides an exceptionally bright finder image. Highly suitable for snapshots using wide angle lenses. The lack of matte surface means depth-of-field effects cannot be ascertained. The meter needle does not indicate proper exposures, because its movement varies depending on the lenses used.
<b>1-6</b> <b>Microprism-clear</b> <b>field type</b> (for standard & telephoto lenses)		This screen provides an extremely bright finder image. Focusing is done on the microprism spot. The lack of matte surface means depth-of-field effects cannot be ascertained and the meter needle does not indicate proper exposures.
<b>1-7</b> <b>Microprism-clear</b> <b>field type</b> (for super telephoto lenses)		Developed primarily for use with super telephoto lenses, this clear field screen provides an extremely bright finder image. The microprism spot remains bright even with a lens whose maximum speed is F 11. The lack of matte surface means depth-of-field effects cannot be ascertained, the meter needle does not indicate proper exposures.

TYPE	SCREEN	FEATURES
<b>1-8</b> <b>All matte type</b> (for telephoto lenses & astronomical telescopes)		This screen is ideal for use with super telephoto lenses of 300mm or more in focal length, or for astrophotography. The extreme fineness of the matte surface permits outstanding field definition. More accurate focusing may be achieved by the use of the Varimag ni Finder.
<b>1-9</b> <b>Clear field type</b> (for endoscopic photography)		Designed for use with OLYMPUS fiberoptic endoscopes. This condenser type screen without fresnel lens requires no focusing when a special adapter couples the camera with the fiberscope. Exposure is made automatically by the light supply.
<b>1-10</b> <b>Checker-matte type</b> (for Shift lens)		The grid lines engraved on the all-matte surface are used for vertical and horizontal picture alignment. Though originally designed for architectural photography with the Shift lens, it is also suitable for general and super-telephotography, and close-up/macro photography with macro lenses and Auto Bellows.
<b>1-11</b> <b>Cross hairs-matte type</b> (for close-up & macro-photography)		Highly advantageous for close-up and macro photography with Auto Bellows and extension tubes. For focusing in low magnification close-up photography, use the matte area and in macro photography greater than life size, use the double cross hairs the same way as with the 1-12. The meter needle indicates proper exposures, but depending on the conditions of the specimen, the reading must be compensated for.
<b>1-12</b> <b>Cross hairs-clear field type</b> (for photomicrography & macrophotography greater than life size)		The transparent screen offers the photographer focusing with an unusually bright finder image. To focus, first correct your diopter using a dioptic correction lens or Varimag ni Finder so that each line of the double cross hairs can be seen clearly and separately. Then bring the specimen into focus. The meter needle indicates proper exposures, but depending on the specimen's conditions, the reading must be compensated for.
<b>1-13</b> <b>Microprism/split image-matte type</b> (for most lenses)		Most suitable for normal photography, this screen assures pinpoint focusing. The central split image rangefinder is encircled by a microprism collar. Since the outer area has a matte surface, the screen can be used in the same way as the standard 1-1 and 1-3 Screens. When a lens with a maximum speed of F5.6 or slower is used, the prisms darken and the focusing must be made on the matte area.
<b>1-14</b> <b>Microprism/split image-matte type</b> (for most lenses)		Most suitable for normal photography. The central split-image range finder, encircled by a microprism collar, is inclined 45 degrees to allow easy focusing on subjects with vertical or horizontal lines. When a lens with a maximum speed of F5.6 or slower is used, the prisms darken and focusing must be made on the matte area. The meter needle gives correct light readings.

## FLASH PHOTO GROUP

---

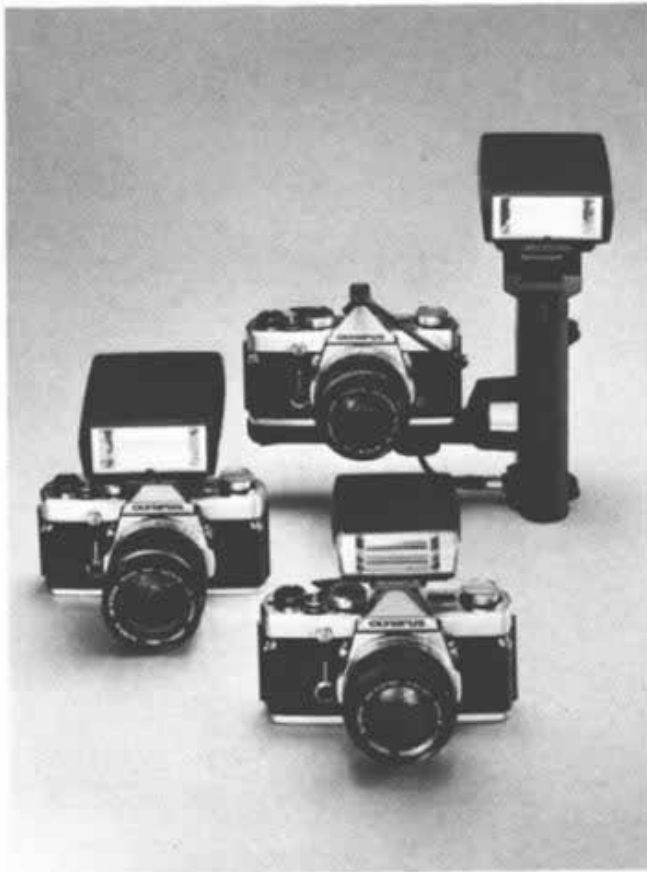

Flash is your own private "sun" when you take pictures at night, indoors, or outdoors for daylight fill-in. At the moment of flash, you can even catch the movement of subjects that your own eyes are unable to follow.

At present the OM System Flashphoto Group renders choice of 5 different flash units, including the Electronic Flash T32 and T20. The T32 offers high performance — a maximum ASA 100 guide number of 32 (in meters) or 104 (in feet) with an angle that virtually covers the picture area of a 24mm super-wide angle lens, and is provided with a built-in bounce mechanism. The T20 is extremely compact and features a maximum ASA 100 guide number of 20 (in meters) or 66 (in feet) with an angle that covers the picture area of a 35mm wide angle lens. The T32 (or T20), when used with the OM-2, is an OTF (off-the-film) fully automatic electronic flash unit. Even the dial settings (auto/manual switching, aperture setting and ASA film speed setting) required of conventional "auto" flash units are unnecessary. By reversing the back plate of the flash unit, it can be used as a normal auto/manual flash unit for use with the OM-1, permitting 3 aperture values of F4, F5.6 and F8 (with T20, two apertures of F4 and F8) at ASA 100 for normal auto flash as well as two manual settings — GN16 (on T32 only) and GN32 (GN 20 with T20).





# FLASH PHOTOGRAPHY SYSTEM CHART

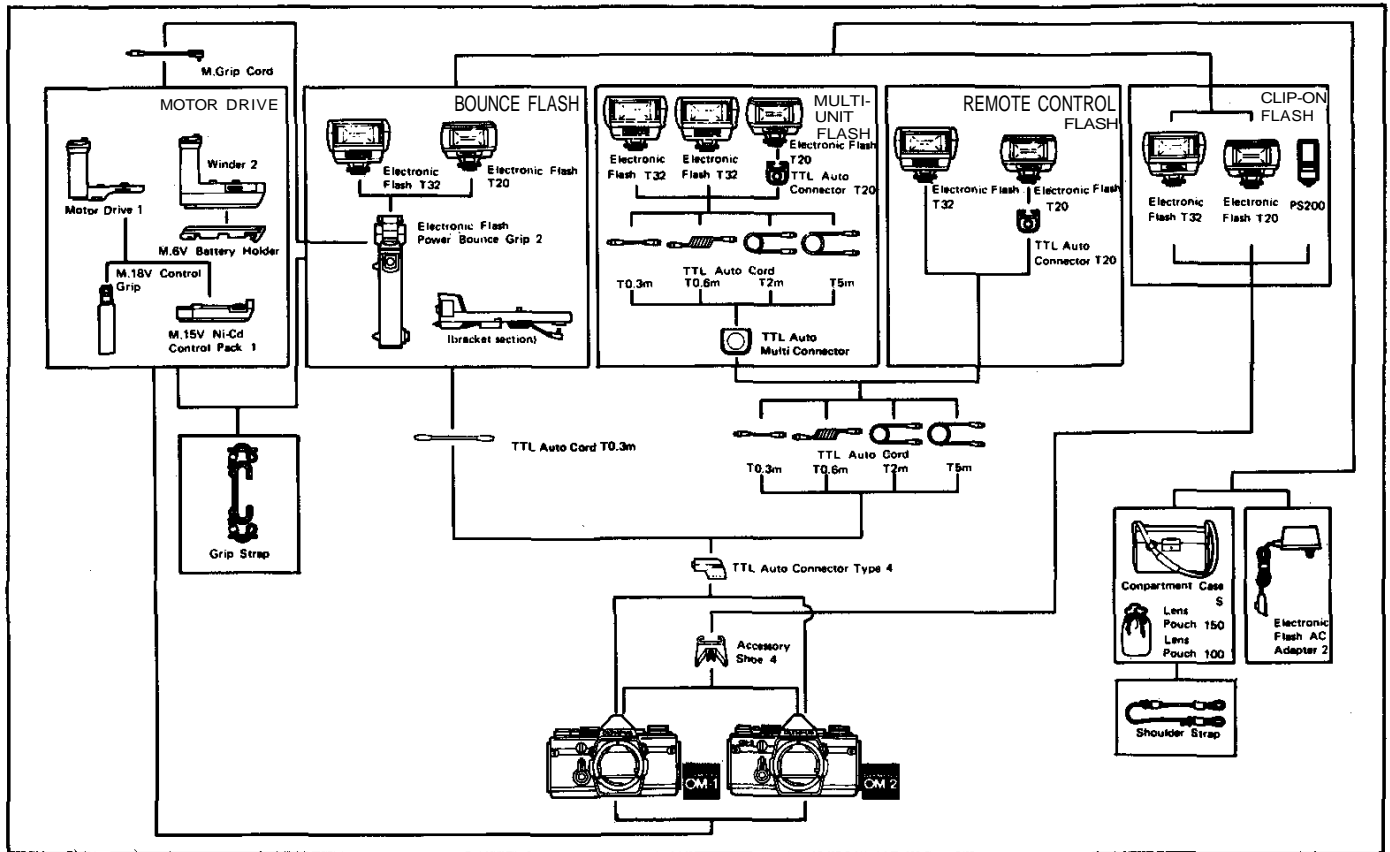



## FLASH PHOTO GROUP UNITS

### ■ Electronic Flash T32

The T32 is the center of the modular OM Flashphoto system. Used alone on the camera, the built-in bounce mechanism allows the flash surface to be tilted 90° up and 15° down. This angle range can be further extended when the T32 is slipped into the Power Bounce Grip 2.



Operates on four 1.5V AA (self-contained) or C batteries (inside bounce grip) including Ni-Cd, or AC house current. 104 x 81 x 70mm (4.1"x3.2"x 2.8"), 320g. (11.3 oz.) less batteries.

### ■ Electronic Flash T20

Extremely compact and lightweight. Like its sister unit T32, the T20 is an energy-saving, fully automatic system flash unit capable of TTL Auto, normal Auto and manual flash and provides the flash charge/correct exposure indication in the OM camera viewfinder (but with no built-in bounce mechanism). Operates



on two 1.5V AA (self-contained) or four 1.5V C (inside bounce grip) including Ni-Cd, or AC house current. 77 x 68 x 57mm (3" x 2.7" x 2.2"), 160g. (5.6 oz.) less batteries.

### ■ T10 Ring Flash 1

Designed principally for use with the OM System macro lenses, this unit provides full and even flash illumination at working distances far closer than possible with other flash units. Operates in conjunction with the T Power Control 1.



### ■ Ring Cross Filter POL

A cross-polarizing filter which minimizes direct reflections from the T10 Ring Flash 1 for highly reflective subject matters.

## FLASH PHOTO GROUP UNITS

### ■ TTL Centralized Control Flash by T32 (T20)/OM-2 Combination

The T32 (T20) utilizes the OM-2's own built-in SBC light sensors. The sensors read the build-up of light from the T32 (T20) which passes through the taking lens to reach the film surface, letting the electronic brain of the camera cut off the flash emission when the correct exposure has been made.

On conventional auto flash units, the auto sensor is built into the flash unit. The sensor regulates flash emission independently of the camera. While normal auto flash units can also give a correct exposure, they are far less versatile and convenient in use. Their drawbacks include:

- ① The need to set film speed and lens aperture on both the camera and the flash unit, which leads to exposure errors caused by mistaken film speed and/or aperture alignment. → With the T32 (T20)/OM-2 combination, once these values have been set on the camera there is no need to reset them on the flash unit.
- ② Restrictions on the f-number that can be used. → With the T32 (T20)/OM-2, f-number can be selected freely because the light is measured through the camera lens.
- ③ Inability to change the light measuring angle of the sensor according to the taking angle of the chosen lens. → With the T32 (T20)/OM-2, light measuring angle always coincides with the picture

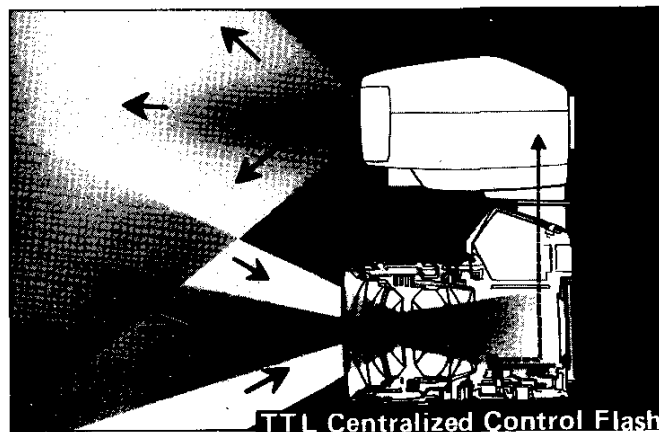

angle of the taking lens.

- ④ Restricted close-up range and incompatibility with extension tubes, etc. → With the T32 (T20)/OM-2, close-up and diffused flash photography can be made easily. As the exposure is calculated inside the camera, the methods of using the flash unit are entirely unrestricted.

■ **T Power Control 1**

A compact power unit for the T10 Ring Flash which mounts via accessory shoe to the top of the OM body. Offers TTL Direct "OTF" auto operation or manual flash (GN 10 and GN 4, ASA 100 in meters). Powered by 4 AA size batteries or optional AC Adapter 3.



- **Calculator panel for 50mm lens**
- **Calculator Panel for 1:1 Macro 80mm lens**
- **Calculator Panel for Macro 135mm lens**

Fitted on to the back of the T10 Power Control 1 to provide easy-to-read distance/magnification/aperture exposure tables. The plate for 50mm lens comes equipped with the T10; other two types are optionally available.



■ **TTL Auto Multi Connector**

Allows multiple flash units (T32s or T20s) to be combined with the camera (OM-2N, or OM-2 in TTL Auto; OM-1N in manual mode) via TTL Auto Cords for simultaneous flash photography.



■ **TTL Auto Connector T20**

Allows the T20 to perform off-camera flash via the TTL Auto Cord T when the Power Bounce Grip 2 is not used (i.e., hand-held or tripod mounted).

## FLASH PHOTO GROUP UNITS

---

### ■ TTL Auto Cords T 0.3m, 0.6m, 2m, 5m

Links the T32 and T20 electronic flash units with the OM body when used separate from the camera. In addition to the 0.6 meter spiral cord, 0.3m, 2m and 5m cords are available.



### ■ M. Grip Cord

Connects the remote shutter release on the Power Bounce Grip 2 for operation with the Motor Drive 1 or Winder 2 units.

### ■ Power Bounce Grip 2

An auxiliary power unit which converts the T32 and T20 electronic flash units into grip-type units. The grip head may be angled in all directions — 90° up and 20° down, 240° to the left, 60° to the right — for maximum versatility in bounce and close-up flash. Grip section houses four 1.5V C size batteries.



### ■ Zoom Adapter T32

Offers concentrated flash beam with the T32 Electronic Flash sufficient for telephoto lenses 135mm and longer.



■ **Wide Adapter-  
ND Filter Set T32**

Special neutral density filters for the T32 Electronic Flash for reducing the light intensity without affecting color and contrast.

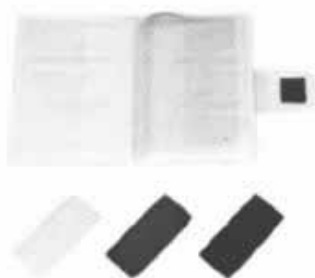

■ **Color Filter Set T32**  
For special effects flash.

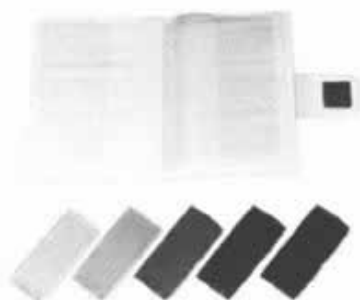

■ **Electronic Flash AC Adapters**  
Enables operation of the T10 Ring Flash 1 and its modelling lamp on AC current.



■ **Electronic Flash AC  
Adapter 2**

Plugged into an AC wall outlet, this unit supplies a virtually unlimited number of economical flashes with the T32 (or T20).

## FLASH PHOTO GROUP UNITS

---

### ■ Lens Pouches 150/100

The Lens Pouch 150 (100) is also suitable for carrying the T32 (T20) electronic flash unit, on its own.



### ■ Compartment Case S

A hard shoulder case with two adjustable partitions to accommodate the OM Body, T32 (or T20), bounce grip and bracket.



### ■ OLYMPUS PS200/PS200 Quick

These manual flash units are for use with cameras with a hot shoe mount, have the guide number of 14 (in meters) or 45 (in feet) at ASA 100 and a constant flash duration of 1/1000 sec. and deliver approx. 200 flashes. The



PS200 operates on two 1.5V AA batteries (recycling time approx. 7 sec.) and the PS200 Quick on four AA batteries (2~3 sec.). PS200: 31 x 55 x 64mm (1.2" x 2.2" x 2.5"), 75g. (2.6 oz.) less batteries. PS200 Quick: 32 x 73 x 71mm (1.3" x 2.9" x 2.8"), 95g. (3.4 oz.) less batteries.

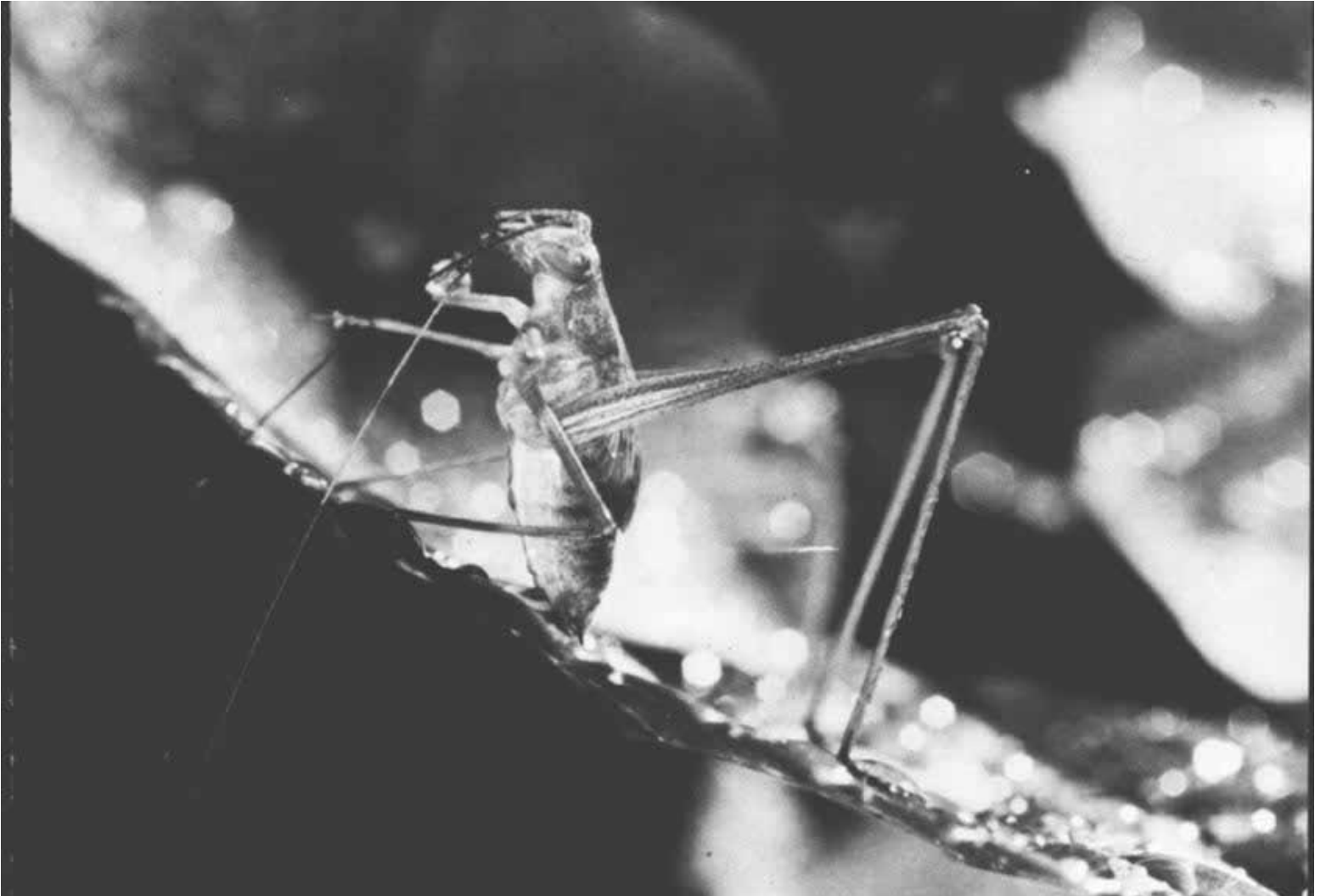

## MOTOR DRIVE GROUP

---



The attraction of the motor drive is its ability to capture fleeting phenomena which exceed the capabilities of human response. Tailored perfectly to match the OM camera body, each unit of the Motor Drive Group has been reduced in size to enhance its maneuverability and ease of operation.

The basic motor drive package (Motor Drive 1 + M. 18V Control Grip 1, or Motor Drive 1 + M. 15V Ni-Cd Control Pack 1) features an amazingly compact and lightweight design, permitting handheld photography even with a 300mm telephoto lens, for shooting sports and news events or other action subjects. The Winder 2 is designed for the ultimate compactness operating on self-contained batteries to perform single or sequential shooting. The 250 Film Back 1, which holds enough bulk film to give 250 exposures, attaches to the OM camera body without cords. The M. AC Control Box is useful for copy work, time-lapse and other photography by transforming household current to DC for motor drive use via a relay cord.

The many uses of the units of the Motor Drive Group in conjunction with other units of the Macrophoto, Photomicro and Flash Photo Groups permit even a greater range of photographic possibilities with the motor drive than originally imagined.





# CHART OF MOTOR DRIVE GROUP

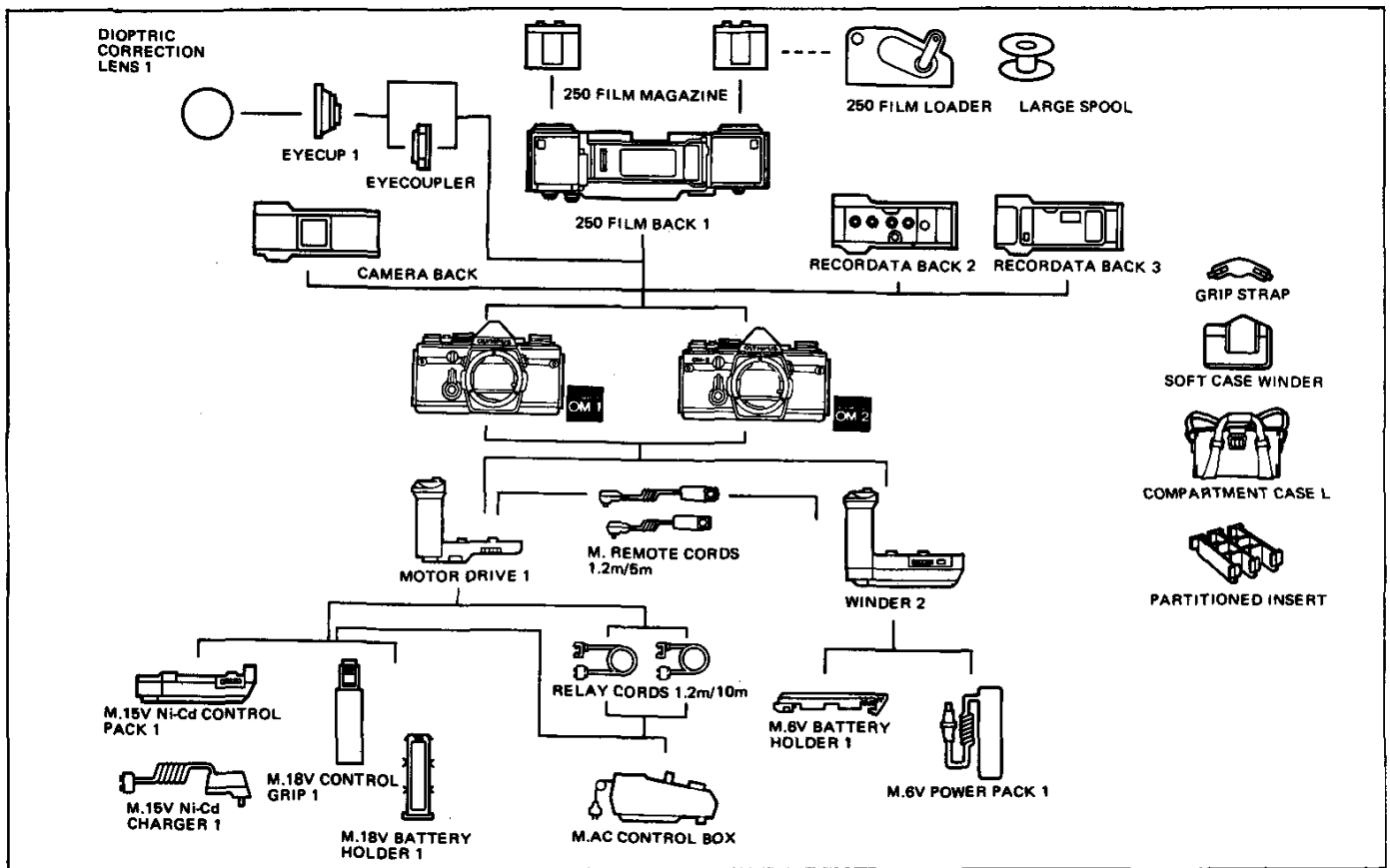

## MOTOR DRIVE GROUP UNITS



### ■ Winder 2 (with M. 6V Battery Holder 1)

Attached directly to the camera base, the Winder 2 performs single frame as well as sequential shooting (2.5 fps).

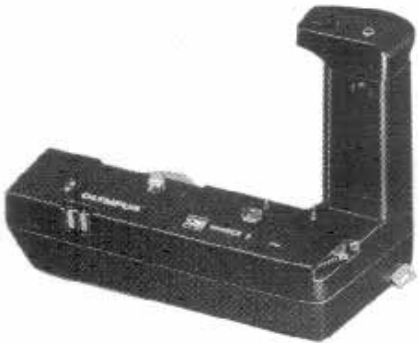

Operating on 4 self-contained AA Alkaline batteries, it is capable of powering approx. 50 rolls of 36-exposure film.

Size: 130 X 64 X 98mm (5.12 X 2.52 X 3.86 in.). Weight: 290g (10.2 oz.) (less batteries).

### ■ M. 6V Power Pack 1

This pocketable power unit (4 AA batteries) connects to the

### ■ Motor Drive 1

The basic motor drive unit that forms the foundation of the group. Attached directly to the camera base together with the power supply. It is capable of single frame shooting and sequential filming of 5 frames per second.



Size: 116 X 82 X 66mm (4.57 X 3.23 X 2.59 in.). Weight: 210g (7.4 oz.).

---

Winder 2 via a 1.2m cord. Warmed by photographer's body heat, permits operation in temperatures as low as  $-10^{\circ}\text{C}$  ( $14^{\circ}\text{F}$ ).

### ■ M.18V Control Grip 1 (with M. 18V Battery Holder 1)

A power supply that accepts 12 AA batteries. Can be attached quickly to the Motor Drive 1.

Size: 136 X 87 X 32mm. Weight: 160g (less batteries).



### ■ M. 15V Ni-Cd Control Pack 1

This is a flat-type rechargeable power unit equipped with a built-in Ni-Cd battery to power the Motor Drive 1.

Size: 129 X 35 X 67mm. Weight: 260g.

## MOTOR DRIVE GROUP UNITS

---

### ■ M.AC Control Box

AC transformer for use with household current. Incorporates a selector switch between single-frame and sequential exposure operation, a terminal for the relay cord and an intervalometer.



### ■ M. 15V Ni-Cd Charger 1

This AC adapter is necessary to charge the M. 15V Ni-Cd Control Pack 1.

### ■ 250 Film Back 1;250 Film Magazine

Used with the Motor Drive 1 or Winder 2 for roll films up to 250 exposures. Two Magazines are necessary.



### ■ Relay Cords 1.2m and 10m

Extension cords between the Motor Drive 1 and the power source for remote control.

### ■ 250 Film Loader

Used in the darkroom for loading the 250 Film Magazine from 33m (100 ft.) bulk film rolls.



### ■ Compartment Case L

#### ■ Partitioned Insert

Can be slung over the shoulder or carried by hand. If used with an optionally available partitioned insert, the Case L accommodates motor drive equipment.

#### ■ M. Remote Cords 1.2m/5m

To be fitted into the remote control jack of the Motor Drive 1 and Winder.

## MACROPHOTOGRAPHY GROUP



Due to recent advances in macrophotography, it has become possible to discover patterns and colors of unsuspected beauty in the minutiae of nature. A fast growing number of scientists and amateurs are taking the opportunity to explore the living world around them to new depths.

The Macrophotography Group of the OM System provides all the tools necessary to capture this world of perfection on film, offering a complete range of convenient high performance accessories designed for specialists in the various fields of macrophotography. Starting from close-up photography with simple accessories such as Close-up Lenses, and Extension Tubes, you can extend your photographic excursions into the macro-photo world with the five Macro Lenses, Auto Bellows, Stands, Adapters, and a large variety of lighting equipment. This Group has no equal in its wide variety of accessories for macrophotography with a magnification range from 1/10x to about 10x, and heightens the value of the OM System in pursuit of perfection on film.

# CHART OF MACROPHOTOGRAPHY GROUP

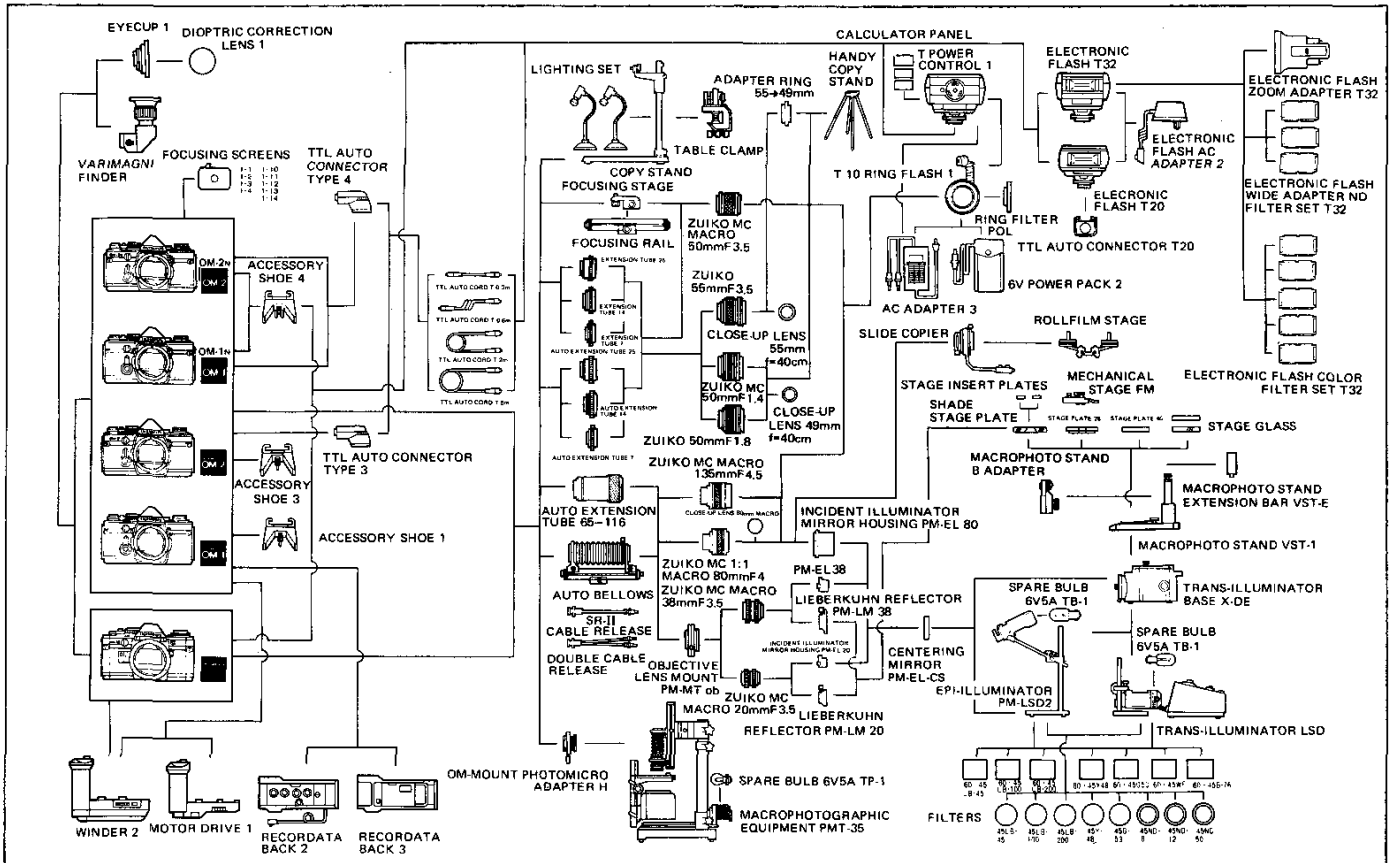

## MACROPHOTOGRAPHY GROUP UNITS



### ■ Telescopic Auto Tube 65-116

Featuring automatic diaphragm linkage and offering continuous extension from 65mm—116mm, it allows you to vary magnifications and subject area freely making macrophoto work as easy as snapshots. Subject area



extends to 72mm x 48mm (2.8" x 1.9") when used in conjunction with the 135mm macro lens, and runs all the way from 72mm x 48mm (2.8" x 1.9") to 36mm x 24mm (1.4" x 0.9") in conjunction with the 1 : 1 Macro 80mm lens.

### ■ Auto Extension Tubes 7, 14 and 25

Each of these bayonet mount tubes fits between the OM Body and the lens, featuring automatic diaphragm linkage. Available in extensions of 7mm, 14mm and 25mm, and can be used in 7



different combinations in total to give a variety of magnifications. Another set of these extension tubes of the same sizes without the automatic diaphragm linkage is also available. For magnifications 0.5x and higher however, the 50mm macro lenses are recommended for superior resolution.

### ■ Close-up Lens 49mm f=40cm

### ■ Close-up Lens 55mm f=40cm

These attachment lenses thread directly over the standard lenses or 50mm macro lens, permitting magnification increase without affecting automatic diaphragm action. The close-up lens



49mm is used with the 50mm F1.8 and F1.4 standard and 50mm macro lenses; the close-up lens 55mm with the 55mm F1.2 standard lens.

### ■ Close-up Lens 80mm Macro

For use with the MC 1 : 1 Macro 80mm lens to extend magnifications with the Telescopic Auto Tube from 1x to 2x.



---

#### ■ Auto Bellows

A basic unit extending your close-up and macrophotographic capabilities. Provided with the preset aperture diaphragm lever to stop down the lens opening of various OM lenses at the moment of exposure in conjunction with the double cable release.



#### ■ Focusing Rail

This is used with the Focusing Stage and connects to a tripod, the Copy Stand, or Macrophoto Stand B Adapter, so that the camera can be smoothly moved along the Rail, allowing you to focus and compose as desired.



#### ■ Slide Copier

For use in conjunction with the Auto Bellows to produce duplicates from frame-mounted slides or strip slides. The 1:1 Macro 80 mm is recommended for best result with the Slide Copier.



#### ■ Objective Lens Mount PM-MTob

This objective mount enables you to mount the Zuiko Macro 20mm and 38mm to the Auto Bellows.

#### ■ Focusing Stage

Allows you to mount the camera body on the Focusing Rail or Auto Bellows. When used with the Rail, you can change the camera position for fast and smooth focusing and composing.

#### ■ Roll Film Stage

Attached to the Slide Copier to hold long roll films for duplication.



■ **Power Bounce Grip 2**

Converts the T32 (or T20) into a grip type electronic flash unit. Consists of a bracket section and a grip section which contains 4 C batteries to provide a powerful supplementary power source.



The bounce head can be angled 90° up, 20° down, 60° right and 240° left allowing free choice of bounce and close-up flash photography. Electrical connection with the camera is made via the TTL Auto Cord T and TTL Auto Connector.

■ **TTL Auto Cord T 0.3m, 0.6m, 2m, 5m**

Used for off-camera flash operation (e.g., bounce flash, multi-unit flash). Available in 4 different lengths.



■ **M. Grip Cord**

Connects the Motor Drive 1 (or Winder) with the shutter release incorporated in the bounce grip for comfortable motor-driven flash photography.

■ **Electronic Flash AC Adapters**

Enables operation of the T10 Ring Flash 1 and its modelling lamp on AC current.



■ **6V Power Pack 2**

An auxiliary power source unit for the modelling lamp of the T10 Ring Flash or winder units. Powered by four D size batteries.

■ **Electronic Flash AC Adapter 2**

## MACROPHOTOGRAPHY GROUP UNITS

### ■ Macrophoto Stand VST-1

A rugged stand specially designed for close-up and high magnification photography. Usable with various stage plates. Complete with a round frosted plate (black at back) for incident light, and a pair of stage clips.



### ■ Macrophoto Stand B Adapter

For use with the Macrophoto Stand, to support the Auto Bellows or Focusing Rail on the Stand.

### ■ Macrophoto Stand Extension Bar VST-E

Extends the height of the Macrophoto Stand. Length: 7.5cm (2.95").

### ■ Trans-Illuminator Base X-DE

Indispensable for holding the Macrophoto Stand VST-1 for magnified photographs. Supplied with a built-in 100V 20W illuminator with a mirror, and a pair of wooden handrests for ease of operation. Can be used with various stage plates and filters.

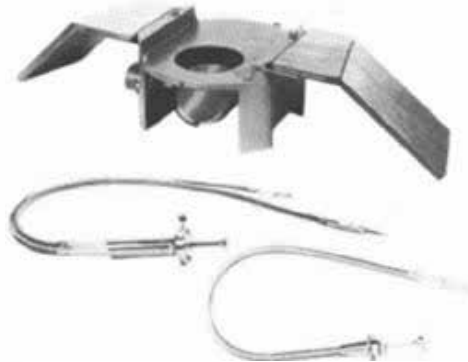

When used with the Lieberkuhn Reflector, it is convenient to replace the reflector mirror with the Centering Mirror PM-ELCS.

### ■ Double Cable Release

Attached to the Auto Bellows and camera shutter release button, to activate them simultaneously.

### ■ Cable Release SR-11

81

### ■ Copy Stand

A standard type stand, 48 x 44 cm, for general close-up and copy photography. Two additional lights can be attached to the top of the 80cm high stanchion. Fine adjustment for the camera height and a locking device are provided.



### ■ Handy Copy Stand

A four-legged stand for close-up and copy photography. The leg length is adjustable to three positions.

### ■ Lighting Set

Complete with two units, each consisting of a base and light arm. Max. intensity: 500W.

■ **Epi-Illuminators PM-LSD 2**

This pair of illuminators offers vertical illumination essential to macrophotography. The height of the illuminator is adjustable on the tall pillar, suitable to over-stage or substage illumination. When used with the Trans-illumi-



nator Base X-DE, the Illuminator supplies transmitted light. Focusing is adjustable by shifting the bulb filament. A 6V to 8V variable transformer is provided. Eight filters are available in various sizes, including color, black and white, neutral density, etc. for transparent or translucent subjects.

■ **Trans-Illuminator LSD**

This unit is a universal type trans-illuminator for use with the X-DE Trans-Illuminator Base. When the Lieberkuhn Reflector is added, vertical light is also available. A 6V, 30W bulb is built-in. The condenser travels 18mm by rack and pinion for converging, diverging and parallel adjustments



of light. Complete with transformer and square filter 60 x 45C. Provided with a filter holder for attachment of various OLYMPUS filters, round and square.

■ **Lieberkuhn Reflector PM-LM38**

■ **Lieberkuhn Reflector PM-LM20**

These reflectors are available for use with the 20mm and 38mm Macro Lenses. When used with the LSD Trans-Illuminator, they make it possible to take photographs with excellent penetra-



tion and lack of shadows.

■ **Centering Mirror PM-ELCS**

For use with these PM-EL units for accurate centration or for use with the Trans-Illuminator Base X-DE.

## MACROPHOTOGRAPHY GROUP UNITS

### ■ Incident Illuminator Mirror Housings PM-EL80, PM-EL38 and PM-EL20

These units are used with OLYMPUS Macro Lenses in conjunction with the Epi-Illuminator PM-LSD2 or Macrophotographic Equipment PMT-35 to illuminate macrophotographic



objects with incident light. They are effective when shadowless pictures are desired.

### ■ Spare Bulb 6V 5A TB-1 (for PM-LSD2 & LSD)

### ■ Spare Bulb 6V 5A TP-1 (for PMT-35)

### ■ Adapter PM-EA

Accepts the photosensitive probe of the EMM-7 Exposure Meter in conjunction with the PMT-35 or Auto Bellows.

### ■ Stage Glasses (Clear, frosted & black)

### ■ Stage Plate 45 (metal disc, black)

### ■ Stage Plate 28 (metal disc, black)

### ■ Glass Shade Stage Plate

Supplied with two stage inserts;



compatible with the Lieberkuhn Reflector. The center port accepts the stage insert on which a subject is placed.

### ■ Mechanical Stage FM

This stage is used to mount subjects on the 28mm stage plate. The subject travels vertically and horizontally by precise adjustments with a vernier.



### ■ Filters

Round filters are used with the PM-LSD2 and LSD, while square filters used with the LSD only. They are available for color temperature compensation, monochromatic, neutral density, diffusion, heat absorbing and interference filtration.

## PHOTOTECHNICAL GROUP



As a leading manufacturer of optical instruments in various fields of modern life, OLYMPUS provided the OM System with a wide variety of Phototechnical units, many of which can be used to successfully document your valuable achievements in photographs. This group includes a microscope adapter for use with an operation microscope, an astroscope adapter to explore the mysteries of space and stars in conjunction with a telescope, etc., mostly capable of attaching on the OM body. Other outstanding advantages of this group are the Recordata Backs 3 and 2 that are interchangeable with the OM standard camera back. Once in place, the No. 3 Back automatically records the date (year-month-day) or the time (day-hour-minute) in the lower right hand section of your picture (camera held in the horizontal position) simultaneously with the shutter release.

Externally, data can be displayed on the liquid crystal panel. Meanwhile, the No. 2 Back imprints numerical and alphabetical symbols in 4-dial coding on the picture when the exposure is made, of great convenience in documentation, information filing, instant picture classification, etc. Both Backs can be used for high speed motor drive photography and flash photography.

For Olympus Pen F and FT enthusiasts, a mount adapter is also available for connection of these cameras to the OM System interchangeable lenses and other unit





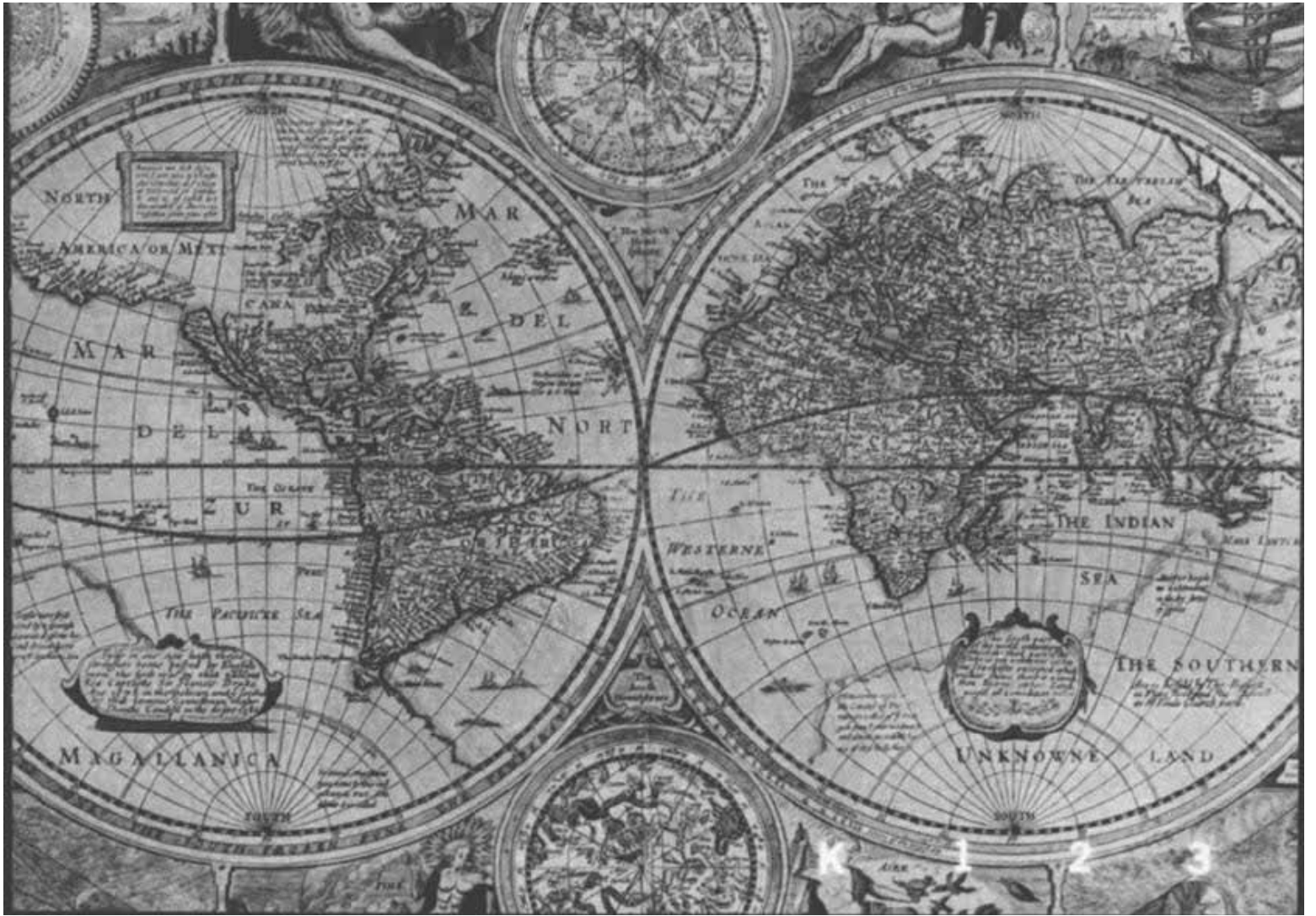

# CHART OF PHOTOTECHNICAL GROUP

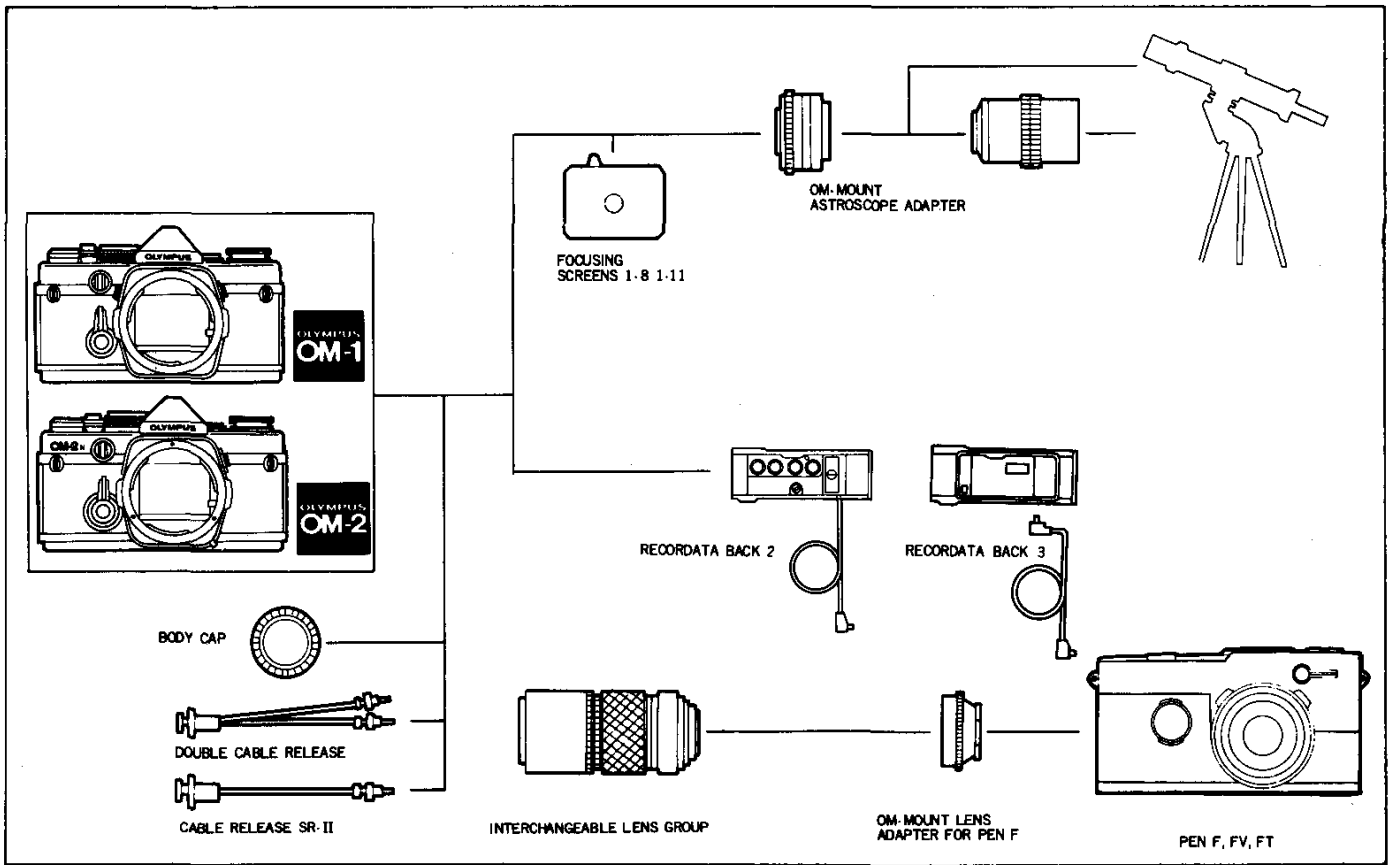



## PHOTOTECHNICAL GROUP UNITS



### ■ Recordata Back 3

This unit replaces the standard camera back to automatically record the date (year-month-day) or the time (day-hour-minute) on the film simultaneously with the exposure, or blank as desired. Data display on the liquid crystal panel.



### ■ Recordata Back 2

The Back fits on the OM body and imprints data in the lower right corner of the picture. The data comprises numerical and alphabetical symbols for year, month, day or other information in 4 dial coding. Can be used for

### ■ OM-Mount Astroscope Adapter

Permits astrophotography by the OM Body attached to telescope by means of the 36.5mm diam., pitch 1mm and pitch 0.75mm threads. It enables direct objective photography and high magnification photography through the telescope eyepiece.



highspeed sequence photography with the Motor Drive or Winder units, and flash photography. Imprinting can be prevented, if required, by simply setting the selector switch OFF.

### ■ OM-Mount Lens Adapter for Pen F

Connects the OLYMPUS PEN F, FT and FV cameras to the OM System Interchangeable Lenses and other units.



### ■ Double Cable Release

Used with the Auto Bellows.

### ■ Cable Release SR-11

## PHOTOMICROGRAPHY GROUP

---



When the photographic magnification desired exceeds 10x, it becomes more difficult for the macro-photographic equipment alone to obtain excellent pictures. A sophisticated array of photomicrography accessories with a microscope as the central figure is required. The exciting vision of looking at the microscopic world through a microscope can be recorded by the OM-2.

OLYMPUS has an outstanding reputation for manufacturing precision microscopes used by scientists throughout the world. Naturally, the OM System includes a variety of microscope adapters, rugged stands, a special shutter to prevent vibration at high magnification, and an automatic exposure mechanism which solves the difficult problem of microscope exposures.

The Photomicrography Group is designed to expand the photomicrographic world not only into the scientific realm, but also into the creative sphere, so that the photographer's achievements under the microscope can be easily and accurately recorded with his OM-2.

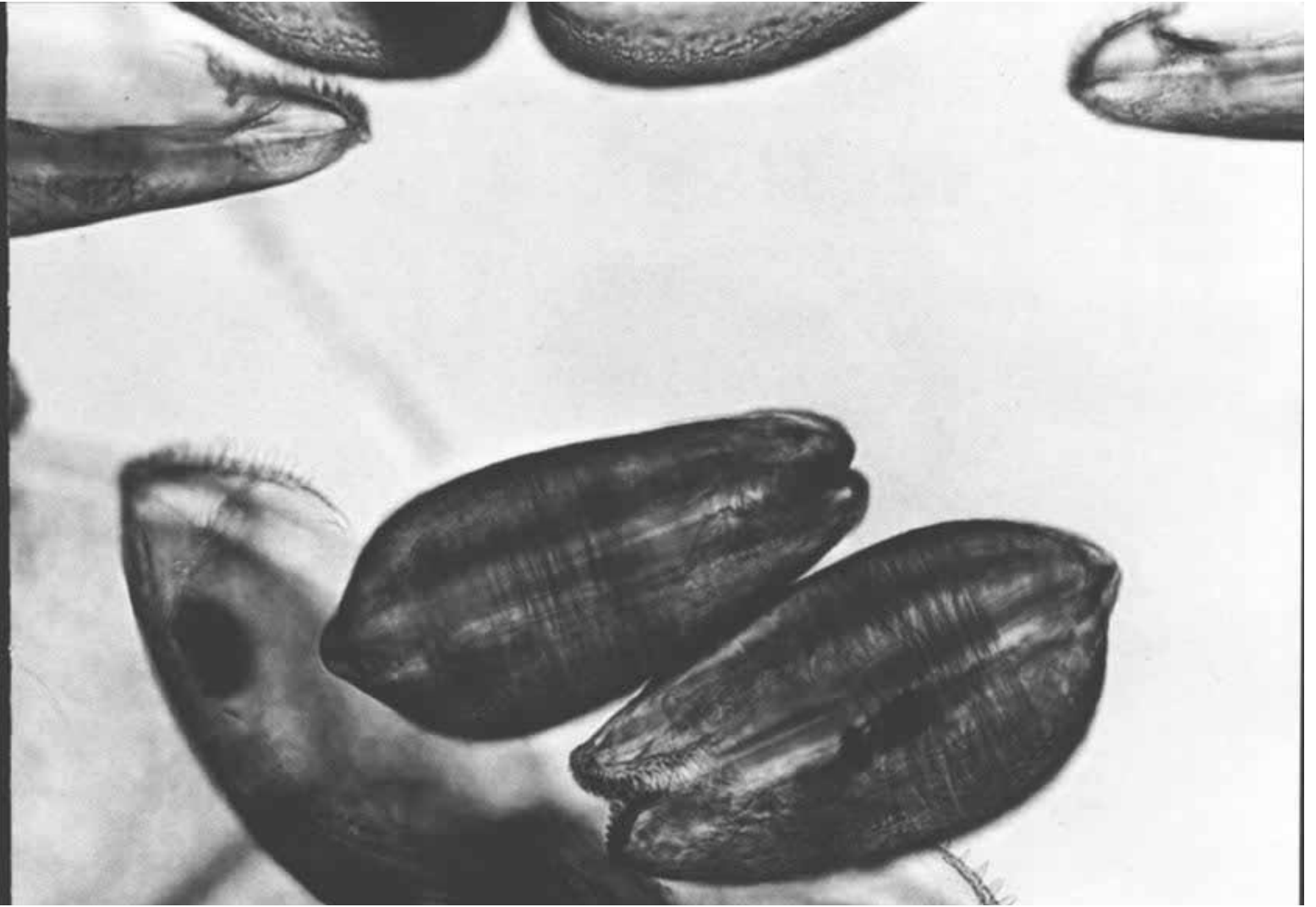

# CHART OF PHOTOMICROGRAPHY GROUP

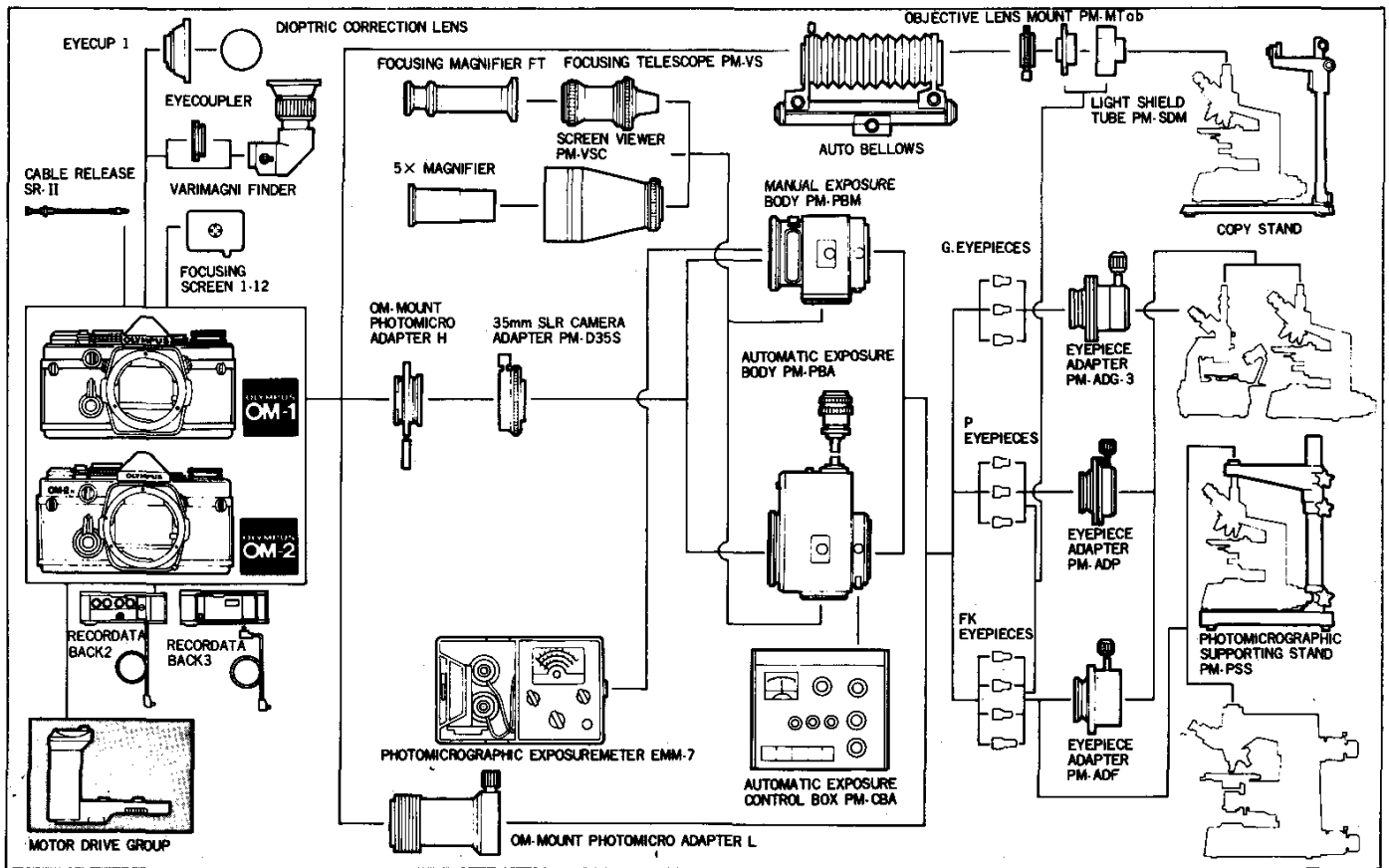

## PHOTOMICROGRAPHY GROUP UNITS



### ■ OM-Mount Photomicro Adapter L

Connects the OM Body to the microscope for low power magnification.



### ■ 35mm SLR Camera Adapter PM-D35S

Used with OM-Mount Photomicro Adapter H to attach the OM Body to the PM-PBA or PM-PBM (see page 93).



### ■ Photomicrographic Supporting Stand PM-PSS

This unit is a massive stand to virtually end the major cause of lost photomicrographs at high magnification due to vibration. Supports the entire camera weight, isolating it from the microscope.

### ■ Eyepiece Adapter PM-AOG-3, PM-ADP, PM-ADF

Used to connect a microscope to the OM-Mount Photomicro Adapter L. Each Adapter designates OLYMPUS microscope eyepieces, as follows; PM-ADG-3 for G eyepieces, PM-ADP for P eyepieces and PM-ADF for FK photo eyepieces.



### ■ OM-Mount Photomicro Adapter H

Connects the OM Body to the Photomicrographic System PM-10, automatic or manual, or Macrophotographic Unit PMT-35 for high power magnification.

### ■ Light Shield Tube PM-SDM

Designed for use with the Auto Bellows and Objective Lens Mount PM-MTob. Assures excellent images when used with FK photo eyepieces at the bellows length of 111mm (4.4"), free of shutter vibration.

## PHOTOMICROGRAPHY GROUP UNITS

---

### System PM-10-AD

Consists of 17 units, including the PM-PBS, PM-CBAD, etc.

#### ■ Automatic Exposure Body PM-PBS

Automatically determines accurate exposure time.



#### ■ Automatic Exposure Control Box PM-CBAD

Used with the Automatic Exposure Body PM-PBS, to regulate color temperatures control, reciprocity failure, etc.

### ■ Manual Photomicrographic System PM-10-M

This is a popular manual version of the PM-10, consisting of 8 units.

#### ■ Manual Exposure Body PM-PBM



#### ■ Photomicrographic Exposure Meter EMM-7

The EMM-7 assures accurate control of both exposure and color temperature in photomicrography. Provided with exposure and color temperature probes, and color-compensating filters.

### ■ 5X Magnifier

For use with the Screen Viewer for magnifying any part of the subject area and focusing accurately.



### ■ Focusing Telescope PM-VS

For use with objectives 4x and up in conjunction with the Automatic or Manual Exposure Body.

#### ■ Focusing Magnifier FT

Used to magnify the image obtained by the Focusing Telescope.

# CHART OF PHOTOGRAPHIC RANGES

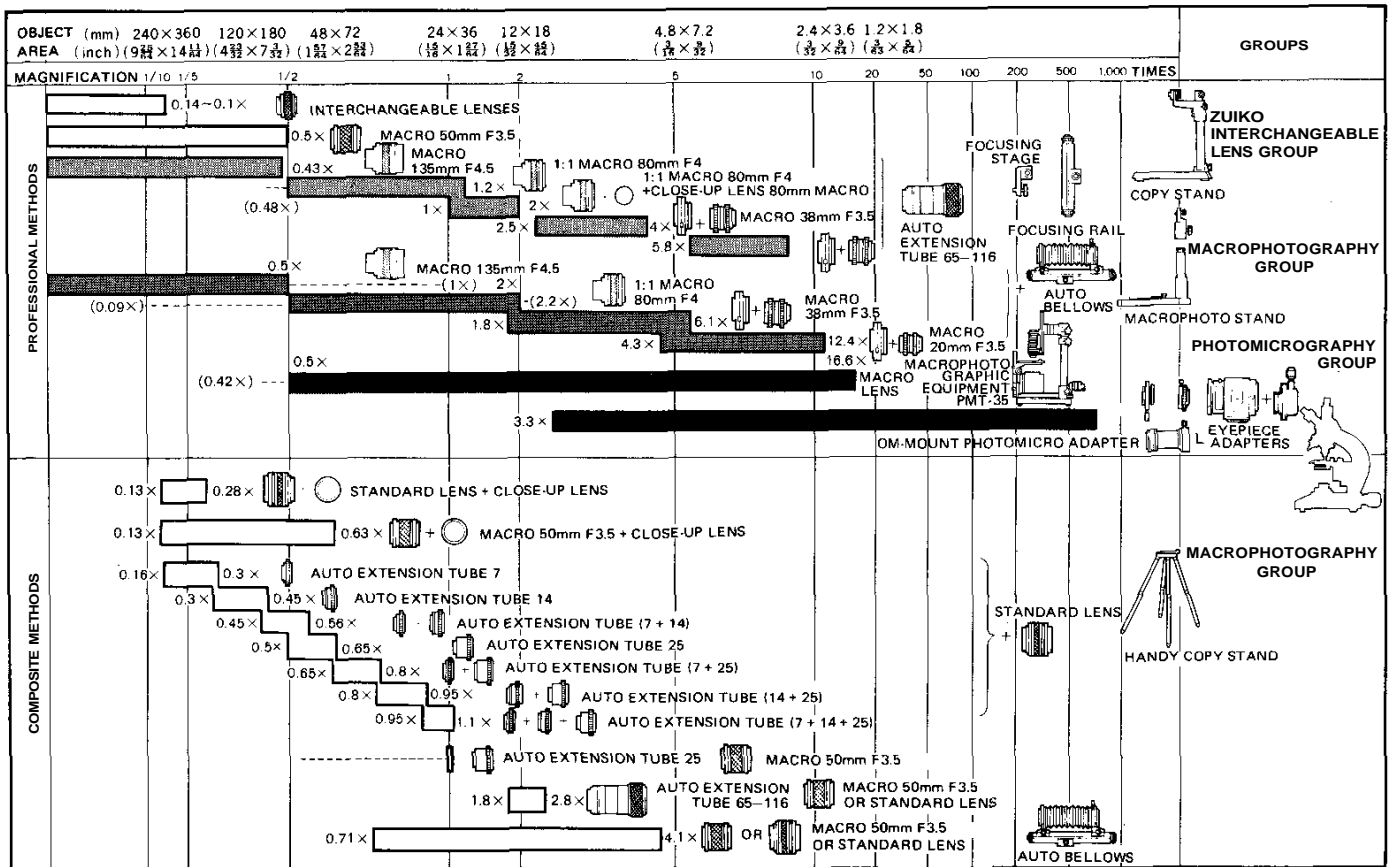

## CASE GROUP

The Case Group includes a large variety of cases that the OM Body and other components fit properly.

Compartment cases are specially made of tough synthetic leather, designed to perfectly accommodate camera bodies, lenses, motor drive, electronic flash units, etc. The adjustable partitions can be rearranged in the case to suit the photographer's individual requirements. Soft, hard and semi-hard cases fit the OM Body and standard lenses, with a choice of carrying straps.

## CASE GROUP UNITS

### ■ Hard Case for OM Body with F1.8 or F1.4

### ■ Hard Case for OM Body with F1.2

Accommodates the OM Body with respective standard lens.

### ■ Semi-Hard Case for OM Body with F1.8 or F1.4



### ■ Semi-Hard Case for OM Body with F1.2

### ■ Soft Case for OM Body with F1.8 or F1.4

Accommodates the OM Body with F1.8 or F1.4 50mm lens.

### ■ Soft Case for OM Body with F1.2

### ■ Lens Pouch 100

Made of fine leather to contain a single 100mm lens or smaller lens or Electronic Flash T20.

### ■ Lens Pouch 150

### ■ Lens Pouch 200

A fine leather container for a



200mm telephoto lens, zoom lens, or smaller. Also holds the main body of Electronic Flash T32.

### ■ Lens Pouch 300

Accommodates 300mm and 180 mm telephoto lenses.

### ■ Various Shoulder Straps



■ **Compartment Case S**

A hard shoulder case with two adjustable partitions. Holds OM Body with two interchangeable lenses and filters, or with Electronic Flash T32 and Bounce Grip.



■ **Compartment Case M**

A soft shoulder case with partitions and two pockets. Holds OM Body, three interchangeable lenses and various auxiliary equipment including electronic flash. It also accommodates clothing and toiletry for traveling, in addition to photographic



■ **Compartment Case L**

A hard shoulder or hand-carried case with two adjustable partitions. Holds two OM Bodies, two interchangeable lenses (including 300mm telephoto lens), electronic flash, large format camera, and other equipment.



■ **Camera Holder for Case M**





Besides the camera holder provided with the Case M, one more camera holder is attachable on the right or left wall of the case as preferred. These holders can hold two camera bodies simultaneously.

equipment, permitting camera and lenses to be taken out freely. Removable partitions are provided to hold cameras and lenses in position safely without their individual cases, permitting quick lens changing on the camera inside the case.

■ **Partitioned Insert**

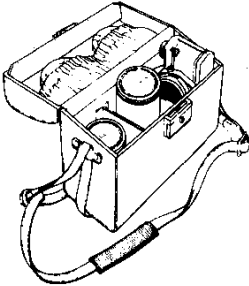
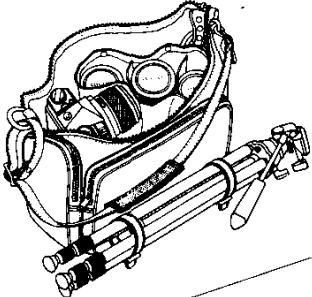
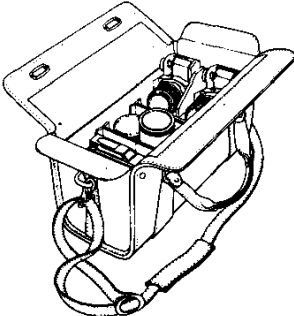
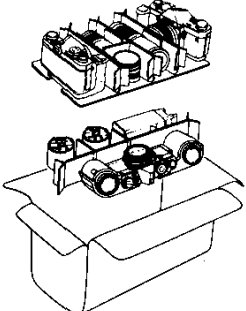
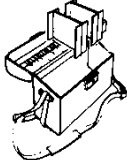
When inserted into the Compartment Case L, this unit supports the assembly of the Motor Drive Units. The 250 Film Back 1 and interchangeable lenses can be stored together with the OM Body.

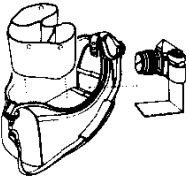
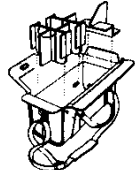
# CHART OF CASE GROUP

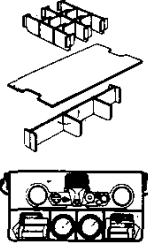
Compartment Case S	Compartment Case M	Compartment Case L	Motor Drive Partitioned Insert
			
 		 	

## MAIN SPECIFICATIONS



**System:** OLYMPUS OM System.

**Camera type:** 35mm Single Lens Reflex with automatic exposure control electronic focal plane shutter.

**Film format:** 24mm x 36mm.

**Lens mount:** OLYMPUS OM Mount, bayonet type; rotation angle 70°, flange back focus distance 46mm.

**Shutter:** Focal plane shutter, automatic exposure control from 120 seconds to 1/1,000 second (ASA 100, F1.2, at normal temperature and humidity). Manual exposure: B, 1—1/1,000 sec., ring mounted control.

**Synchro:** FR-X switch type contact, incorrect flash prevention. (Accessory shoe mount for X contact)

**Automatic exposure control:** Aperture-preferred automatic exposure control electronic shutter type. TTL Direct (off-the-film) Light Measuring System. Measuring range: EV-6.5 to EV18 (at ASA 100 with F1.2 lens).

**Exposure range:** Shutter speeds from 120 sec. to 1/1,000 sec, (at normal temperatures and humidities). Light sensors: 2 SBC sensors. Large exposure compensation dial:  $\pm 2EV$  (within the ASA film speed range). Automatic flash exposure: Direct contacts for TTL Auto Flash (full automatic flash with T32, T20 or T10 electronic flash).

**Manual exposure:** TTL type. Measuring system:

Full aperture center-weighted metering. Measuring range: EV1.5-EV17 (ASA 100 with F1.2 standard lens). Light sensors: 2 CdS sensors.

Zero-method with needle visible in viewfinder.

**Film speed setting:** ASA 12—1600, set by lifting and rotating film speed dial.

**Auto/Manual selection:** By selector lever.

**Power source:** Two 1.5V silver oxide batteries SR44 (Eveready EPX-76 or equivalent).

**Battery check:** 3-stage battery check lamp (light emitting diode) indicates full voltage, depleted charge, and exhaustion of batteries. Shutter lock to limit drainage.

**Mirror unlock:** Mirror lock-up can be released simultaneously with battery check.

**Viewfinder:** Pentaprism type wide-vision finder.

**Focusing screens:** Wide selection of interchangeable screens.

Supplied with Focusing Screen 1—13 (microprism split image matter type).

**Finder view-field:** 97% of actual picture field.

**Viewfinder magnification:** 0.92X at infinity with 50mm- lens.

**Apparent field of view:** Vertical 23°30', horizontal 35°.

**Indicators in viewfinder:** 3-stage selector lever. (Auto: Shutter speed indicator. — Manual: exposure index. — Off: nothing). Exposure compensation marker. Charge/Auto check lamp

## MAIN SPECIFICATIONS

---

(with T-series Electronic Flash mounted).

**Reflex mirror:** Oversize, quick return type (without lock-up).

**Film loading:** OLYMPUS easy loading.

**Manual film advance:** Lever type with 150° angle for one long or several short strokes, pre-advance angle 30°, self-cocking, double advance and double exposure prevention.

**Motor drive advance:** With Motor Drive 1 unit attached, single frame and continuous advance at speed of 5-frame per second (at exposures above 1/500 sec., with fresh batteries and at normal temperature and humidity).

**Exposure counter:** Progressive type with automatic reset.

**Film rewind:** Crank type, with rewind release lever setting, automatic return.

**Self-timer:** 4—12 second delay lever type with 180° maximum angle; can be stopped and reset after actuation.

**Camera back:** Removable hinge type, with memo holder.

Interchangeable with Recordata Backs 2, 3 and 250 Film Back 1.

**Hot shoe socket:** OLYMPUS special Accessory. Shoe 4 supplied.

### Dimensions and weights:

**Body only:** 136 x 83 x 50mm  
(5.35" x 3.27" x 1.97") 520g (18.3 oz)

**With F1.8 lens:** 136 x 83 x 81mm

(5.35" x 3.27" x 3.19") 690g (24.3 oz)

**With F1.4 lens:** 136 x 83 x 89mm

(5.35" x 3.27" x 3.50") 750g (26.5 oz)

**With F1.2 lens:** 136 x 83 x 97mm

(5.35" x 3.27" x 3.82") 830g (29.3 oz)



**OLYMPUS®**

**OLYMPUS OPTICAL CO.,LTD.**

San-Ei Building, 22-2, Nishi Shinjuku 1-chome, Shinjuku-ku Tokyo, Japan. Tel. 03-340-2211

**OLYMPUS CORPORATION**

Crossways Park, Woodbury, New York 11797, U.S.A. Tel. 516-364-3000

**OLYMPUS OPTICAL CO.(EUROPA) GMBH**

2 Hamburg 1, Steindamm 105, West Germany. Tel: 040-248021

**OLYMPUS OPTICAL CO. (U.K) LTD.**

2-8 Honduras Street, London EC1Y 0TX, England. Tel. 01-253-2772

PRINTED IN JAPAN IEOM2 © 0800 • 15MS